

**YAESU**

# **FT-1000MP**

## **OPERATING MANUAL**

**VERTEX STANDARD CO., LTD.**

4-8-8 Nakameguro, Meguro-Ku, Tokyo 153-8644, Japan

**VERTEX STANDARD**

**US Headquarters**

10900 Walker Street, Cypress, CA 90630, U.S.A.

**International Division**

8350 N.W. 52nd Terrace, Suite 201, Miami, FL 33166, U.S.A.

**YAESU EUROPE B.V.**

P.O. Box 75525, 1118 ZN Schiphol, The Netherlands

**YAESU UK LTD.**

Unit 12, Sun Valley Business Park, Winnall Close  
Winchester, Hampshire, SO23 0LB, U.K.

**VERTEX STANDARD HK LTD.**

Unit 5, 20/F., Seaview Centre, 139-141 Hoi Bun Road,  
Kwun Tong, Kowloon, Hong Kong

## Table of Contents

<b>General Description</b>	<b>1</b>	<b>Memory Features</b>	<b>47</b>
Specifications	3	Memory Structure	47
Accessories & Options	5	Memory Programming	47
General Setup & AC Power	7	Memory Checking	48
Front Panel Controls	9	Grouping Memories	49
Main Receiver Display Indications	16	Memory Tuning	49
Top Panel Access & Controls	18	QMB (Quick Memory Bank) Operation	50
Rear Panel Controls & Connectors	19	<b>Scanning Features</b>	<b>51</b>
<b>Operation</b>	<b>23</b>	VFO Scanning	51
Receiving	23	Memory Scanning	51
Reverse CW Sideband	24	Scan Resume Modes	51
Tuning The FT-1000MP	25	Memory Masking	52
VFO Operation	27	PMS (Programmed Memory Scanning)	52
AM Synchronous Tuning	29	<b>Digital Modes with the FT-1000MP</b>	<b>53</b>
General Coverage Reception	29	RTTY and AMTOR with a TNC	53
<b>Dealing with Interference</b>	<b>30</b>	300-Baud Packet	55
Front End Selection	30	1200-Baud FM Packet	56
Wide Band & Tuned Amp Selection	30	<b>Advanced Features</b>	<b>57</b>
IPO (Intercept Point Optimization)	30	EDSP	57
AGC (Automatic Gain Control) Selection	31	TX Audio Enhancement	58
Noise Blanker Selection and Setting	31	RX Audio Enhancement	58
IF Bandwidth Selection	32	Auto Multiple Notch Filter	59
IF Width & Shift Control	33	<b>Remote Control Operation</b>	<b>60</b>
IF Notch Filter	34	Contest Keyer Control	60
<b>Transmitting</b>	<b>35</b>	VFO/Memory Control	63
SSB Transmission	36	Main/Sub VFO Control	63
CW Transmission	38	<b>User Customized Operating Mode</b>	<b>64</b>
Keyer Operation	38	<b>Optional DVS-2 Digital Voice Recorder</b>	<b>65</b>
AM & FM Transmission	40	<b>Linear Amplifier Oper. &amp; Interconnections</b>	<b>68</b>
Carrier Point Offset	40	<b>Transverter Operation</b>	<b>70</b>
Clarifier (Rx/Tx Offset Tuning)	41	<b>CAT System Computer Control</b>	<b>73</b>
Offset Display Mode	42	<b>Menu Selection and Settings</b>	<b>85</b>
<b>Using Sub VFO B</b>	<b>43</b>	<b>Installing Internal Accessories</b>	<b>99</b>
Dual Reception	43	TCXO Units	99
Headphone Adjustments	44	2nd & 3rd IF Filters	100
Split Frequency Operation	45	Lithium Battery Replacement	101
Diversity Reception	46	Memory Backup Switch	101
		Tuning Knob Torque Adjustment	102
		DC Operation	103

## General Description



Congratulations on the purchase of your Yaesu amateur transceiver! Whether this is your first rig, or if Yaesu equipment is already the backbone of your station, rest assured that your transceiver will provide many hours of operating pleasure for years to come.

We want you to feel that you are now a part of the Yaesu Team; after all, we also share the exciting hobby of amateur radio communications you do. In fact, Yaesu Musen's history in Amateur Radio goes back to 1959, being the first to introduce and manufacture quality, high-performance SSB transceivers for the amateur market. Yaesu Musen also manufactures a broad range of high-quality commercial equipment that public services, businesses, and mariners depend on every day.

Following the same tradition of excellence and innovation into the twenty-first century, Yaesu Musen paves the way, incorporating the latest microprocessor and RF technology in our communications equipment. Yaesu transceivers have scaled mountains, crossed storm-tossed oceans, and even orbited Earth. Some Yaesu equipment are legends in themselves, such as the classic FT-101, and the industry standard of excellence, the FT-1000D. Each Yaesu model is the result of extensive research, design, and development. Most Yaesu engineers are also licensed amateurs, and they design transceivers with operators in mind. The product of this combined effort is evident in Yaesu equipment's rugged construction, comfortable operation, and of course, high performance.

But the effort doesn't stop here. With the progression of amateur radio along with the high-technology race, each transceiver incorporates a wealth of operating features to help you "keep up with the crowd." User-friendly controls and programming let you easily manage your new operating capabilities, with just a few simple keystrokes!

Along with the philosophy that each Yaesu transceiver should serve you well into the future, Yaesu stands behind our products with a worldwide network of dealers and service centers. Feel free to contact us if you ever need technical advice or assistance.

The FT-1000MP is an advanced, state-of-the-art amateur transceiver incorporating a multitude of new and advanced operating features providing competitive operation in all modes. The FT-1000MP offers dual-VFO reception and adjustable transmitter power output of up to 100 watts on all HF amateur radio bands (25 watts carrier in AM mode). A new evolution in tuning has begun with the new shuttle jog ring that allows large or small frequency excursions with a slight turn of the wrist – fast, precise tuning with no more tiresome cranking.

Most of the transceiver's advanced features and settings are now viewed and selectable from within the menu programming system, which is easily recalled from the front panel – no more power-on sequences, DIP switch settings, or elaborate push-button combinations for your custom settings. Operating frequency and other important settings for both VFOs are viewed on a

bright, colorful fluorescent discharge display. A multi-display meter features delayed "peak-hold" segments and a directional tuning meter to assist in zeroing-in stations, regardless of mode. The new expanded tuning scale lets you view relative clarifier offset or sub-incremental tuning (0.625-, 1.25-, 2.5- or 5-kHz steps).

Station size is kept to a minimum with the compact internal AC switched-mode power supply, built-in automatic antenna tuner and electronic CW keyer. The full-featured keyer has two iambic keying modes, a "bug" emulator, adjustable weighting and ACS (Automatic Character Spacing) circuit to improve your CW sending.

Superb receiver performance is a result of direct lineage from the legendary FT-1000D. New technology Direct Digital Synthesizers (two 10-bit and three 8-bit) are used in the local oscillator (all driven by a single TCXO master oscillator), resulting in extremely fine tuning with thirteen selectable tuning steps down to 0.625 Hz. Select either flat or tuned front end RF amplification (using four FETs in a double push-pull, constant-gain stage), direct feed to the mixer with IPO (Intercept Point Optimization), and three levels of RF attenuation in 6-dB steps.

Two VFOs allow simultaneous reception and display of two different frequencies, even in different modes and with different IF bandwidths. Receiver audio can be completely or partially mixed, or monitored separately in each ear. With independent bandwidth and mode selection for each receiver, plus an option for separate antennas, diversity reception is possible when both VFOs are tuned to the same frequency.

To battle QRM, the FT-1000MP comes equipped with a formidable defense. Fine tailoring of the IF passband is made possible with individually-selected, cascaded 2nd & 3rd crystal filter banks. World-renowned Collins mechanical 500-Hz CW filters are available as options for the Sub Receiver 2nd IF, and Main Receiver 3rd IF strip. An IF notch filter and concentric IF shift and width controls are also provided. The IF width circuit now allows continuously narrowing receiver passband by selectively moving either the upper or lower filter skirt just as much as needed to reduce QRM while still preserving valuable bandwidth.

Yaesu's new EDSP (Enhanced Digital Signal Processing) system provides four random-noise reduction settings, selectable band pass filtering with adjustable low and high-cutoff skirts, and transmitted audio enhancement with four voice

response equalization schemes. In addition, EDSP provides an automatic notch filter that identifies and attenuates heterodynes as they appear.

Separate keys are also provided for band selection, and each band key accesses two sub-band VFO frequency/mode/filter settings per band, so you can keep separate VFO settings for two different parts of the band, on all bands. In addition, 99 scannable memories are provided, each of which stores its own mode and IF filter selection, in addition to frequency, clarifier offset, and scan-skip status. In addition, five quick-recall memories can instantly store operational settings at the push of a button. VFO, band, and memory scanning now have three scan resume modes and an auto-write feature that stores active channel in memories as they are found. The built-in automatic antenna tuner includes 39 memories of its own, automatically storing antenna matching settings for quick automatic recall later. Of course the front panel keypad can also be used to key in operating frequencies directly.

A user-customization key allows recalling pre-configured parameters for often-used operating setups, or unique operating modes such as FAX and SSTV. The special remote control jack allows push-button control of the full-featured programmable CW contest memory keyer, transceiver remote operation and direct frequency entry. CW enthusiasts can take advantage of the CW reverse sideband selection, and shortwave listeners will enjoy the AM synchronous tuning mode.

The Yaesu CAT system provides a direct link to the transceiver CPU for computer control and customization of tuning, scanning and other operating functions. The FT-1000MP now includes a built-in data level converter for direction connect to a personal computer serial port. Special options for the FT-1000MP include the TCXO-4/6 Temperature Compensated Crystal Oscillator modules and a wide selection of IF filters to complement the eight already installed as standard. External options include the DVS-2 Digital Voice Recorder and SP-8 External Loudspeaker with optional LL-7 Phone Patch module; the YH-77STA Stereo Headset; and the MD-100A8X Desktop Microphone.

Before connecting power, please read the Installation section carefully, heeding the warnings in that section to avoid damage to the set. After installation, please take time to work through the Operation chapter, referring to the Controls & Connectors chapter as necessary for details.

## Specifications

### General

Rx frequency range: 100 kHz - 30 MHz  
 Tx frequency ranges: 160 -10m amateur bands only  
 Freq. Stability:  $< \pm 10$  ppm ( $-10 \sim +50^{\circ}\text{C}$ )  
 $< \pm 2.0$  ppm ( $0^{\circ} \sim +50^{\circ}\text{C}$ ) w/TCXO-4  
 $< \pm 0.5$  ppm ( $0^{\circ} \sim +50^{\circ}\text{C}$ ) w/TCXO-6  
 Freq. Accuracy:  $< \pm 7$  ppm (except FM,  $< \pm 500$  Hz)  
 w/TCXO-4:  $< \pm 2$  ppm (FM  $< \pm 460$  Hz)  
 w/TCXO-6  $< \pm 0.5$  ppm (FM  $< \pm 500$  Hz)

Operating temperature Range: ( $-10^{\circ} \sim +50^{\circ}\text{C}$ )

Emission modes: LSB, USB, CW, FSK, AM, FM

Frequency steps: 0.625/1.25/2.5/5/10 Hz for SSB, CW, RTTY & Packet; 100 Hz for AM and FM

Antenna impedance: 50 $\Omega$  unbalanced

Power consumption:

Input	Rx (no signal)	Rx (signal)	Tx (100W)
100~125 VAC	70 VA	80 VA	550 VA
200~240 VAC	80 VA	90 VA	600 VA
13.8 VDC	2.4 A	2.8 A	19 A

Supply voltage: 100~125, 200~234 VAC, 50/60 Hz

Dimensions (WHD): 410 x 135 x 347 mm

Weight (approx.): 15 kg. (33 lbs)

### Transmitter

Power output: adjustable up to 100 watts  
 (25 watts AM carrier)

Duty cycle: 100% @ 50 watts, 50% @ 100 watts  
 (FM & RTTY, 3-minute Tx)

Modulation types:

SSB: J3E Balanced, filtered carrier  
 AM: A3E Low-level (early stage)  
 FM: F3E Variable reactance  
 AFSK: J1D, J2D Audio frequency shift keying

Maximum FM deviation:  $\pm 2.5$  kHz

FSK shift frequencies: 170, 425, and 850 Hz

Packet shift frequencies: 200, 1000 Hz

Harmonic radiation: at least 50 dB below peak output

SSB carrier suppression: at least 40 dB below peak output

Undesired sideband suppression: at least 50 dB below peak output

Audio response (SSB): not more than -6 dB from 400 to 2600 Hz

3rd-order IMD: -31 dB @ 100 watts PEP, or better

Microphone impedance: 500 to 600  $\Omega$

### Receiver

Circuit type: quad-conversion superheterodyne  
 (triple conversion for FM)

Intermediate frequencies: **Main Rx** **Sub Rx**  
 70.455 MHz 47.21 MHz  
 8.215 MHz 455 kHz  
 455 kHz

Sensitivity:

(with preamp on, for 10 dB S/N, 0 dB $\mu$ - 1 $\mu$ V)				
Frequency $\Rightarrow$ Mode (BW) $\Downarrow$	150 – 250 kHz	250 – 500 kHz	0.5 – 1.8 MHz	1.8 – 30 MHz
SSB, CW (2.4 kHz)	5 $\mu$ V	4 $\mu$ V	2 $\mu$ V	0.25 $\mu$ V
AM (6 kHz)	40 $\mu$ V	32 $\mu$ V	16 $\mu$ V	2 $\mu$ V
29-MHz FM (12 dB SINAD)	—	—	—	0.5 $\mu$ V

Selectivity (-6/-60 dB):

Button	Modes	Minimum -6 dB BW	Maximum -60 dB BW
2.4 kHz	all except FM	2.2 kHz	4.2 kHz
2.0 kHz	all exc. AM, FM	2.0 kHz	3.6 kHz
500 Hz	CW, RTTY, Packet	500 Hz	1.8 kHz
250 Hz	CW, RTTY	250 Hz	700 Hz
—	AM (wide)	4 kHz	14 kHz
	FM	8 kHz	19 kHz

Dynamic Range: 108 dB (@50 kHz, 500-Hz BW, RF amp off)

Squelch sensitivity:

1.8 - 30 MHz (CW, SSB, AM):  $< 2.0$   $\mu$ V

28 - 30 MHz (FM):  $< 0.32$   $\mu$ V

IF rejection (1.8 - 30 MHz): 80 dB or better (Main Rx)  
 60 dB or better (Sub Rx)

Image rejection (1.8 - 30 MHz): 80 dB or better (Main)  
 50 dB or better (Sub)

IF shift range:  $\pm 1.12$  kHz

Max. audio output: 1.5 W into 4 $\Omega$  with  $< 10\%$  THD

Audio output impedance: 4 to 8  $\Omega$

*Specifications are subject to change, in the interest of technical improvement, without notice or obligation.*

Plug/Connector Pinout Diagrams

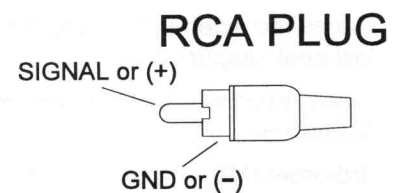
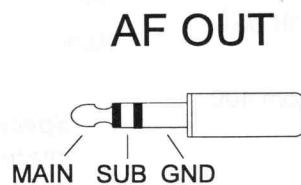
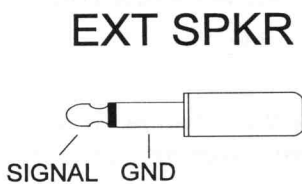
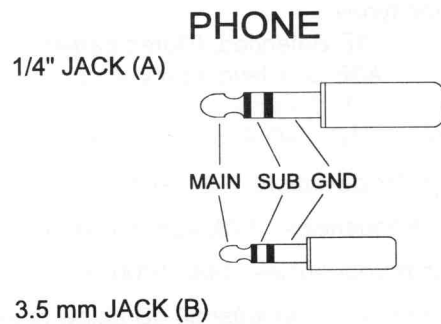
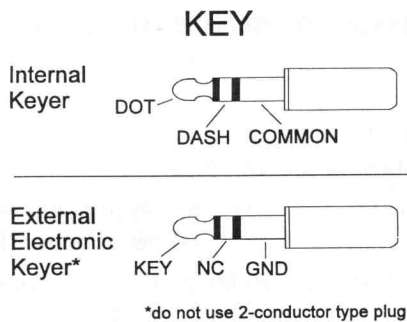
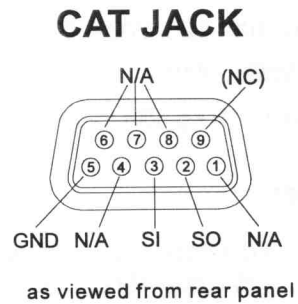
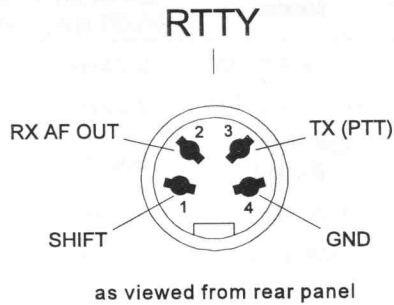
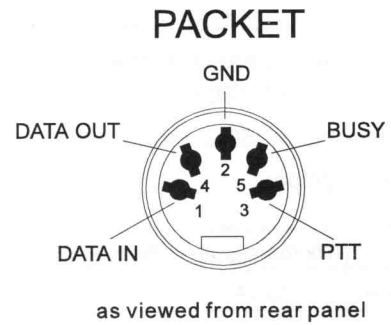
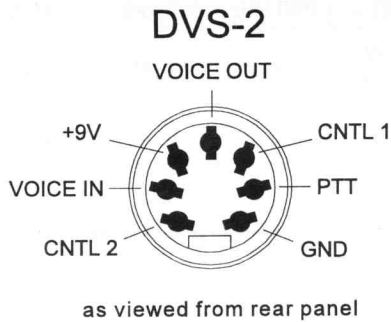
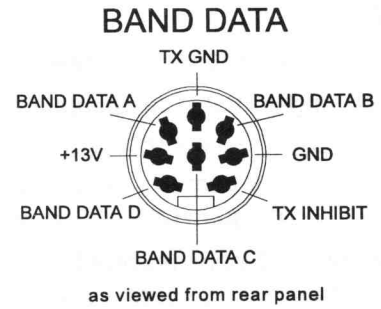
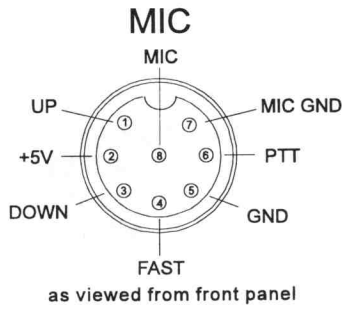

## Accessories & Options

### Options

#### **TCXO-4/TCXO-6 High-Stability Master Reference Oscillators**

For special applications and environments where extra frequency stability is essential, such as for long-term HF packet monitoring under wide temperature variations, the TCXO-4 provides  $\pm 2.0$ -ppm stability, and the TCXO-6 provides  $\pm 0.5$ -ppm stability from 0 to  $+50^{\circ}\text{C}$  for the master reference oscillator.

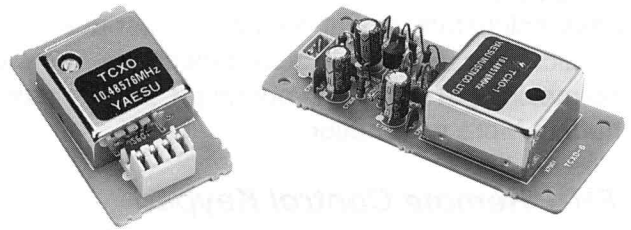

#### **MD-100A8X Desk-Top Microphone**

Designed especially to match the electrical and cosmetic features of the FT-1000MP, the MD-100A8X has 600- $\Omega$  impedance, and includes up/down scanning ring and a large PTT switch with latch.



#### **SP-8 Loudspeaker with Audio Filters and LL-7 Phone Patch Option**

Selectable audio high- and lowpass filters together with a large loudspeaker complement the superb audio characteristics of the FT-1000MP with your choice of 12 different audio filtering combinations. Two input terminals are provided for multiple transceivers, with a front panel switch to select between them. A (monaural) phone jack is provided on the front panel to take advantage of the audio filters with headphones.



With the optional LL-7 Phone Patch Unit installed in the SP-8, the FT-1000MP can be patched to the public telephone network. The LL-7 includes a hybrid transformer circuit to assure proper impedance matches, and front panel gain controls and level meter to set proper audio levels on the telephone line.

#### **YH-77STA Lightweight Stereo Headphones**

Dual samarium-cobalt transducers with sensitivity of 103dB/mW ( $\pm 2$ dB, @1 kHz, 35 $\Omega$ ) provide the perfect match for the FT-1000MP. During dual receive with the YH-77STA, one receiver can be monitored in each ear, allowing easy separation of the signals from the two receivers (or the audio can be mixed, if desired).



### DVS-2 Digital Voice Recorder

Serving as either a continuous receiver recorder for instant pushbutton playback, or microphone audio recorder for multiple on-air playback, the DVS-2 applies the advantages of random-access solid-state digital memory to serious communications. All data is stored electronically, with no moving parts except your finger and the push-button. More information is on page 64.

### FH-1 Remote Control Keypad

The FH-1 is a remote-control accessory designed to enhance the operating flexibility of your FT-1000MP. The FH-1 permits several remote control features, which may be selected via Menu programming. More information is on page 60.

### IF Crystal Filter Options

Five optional crystal filters may be installed in the Main Receiver of the FT-1000MP, and two in the Sub Receiver.

#### Optional Main Receiver Filters

##### 8.2 MHz (2nd IF)

**YF-114SN** 2.0-kHz BW (for all modes except FM)

**YF-114CN** 250-Hz BW (for all except AM & FM)

##### 455 kHz (3rd IF)

**YF-110SN** 2.0-kHz BW (for all modes except FM)

**YF-115C** Collins Mechanical Filter 500-Hz BW (for CW & RTTY)

**YF-110CN** 250-Hz BW (for CW only)

#### Optional Sub Receiver Filter

##### 455 kHz (2nd IF)

**YF-115C** Collins Mechanical Filter 500-Hz BW (for CW & RTTY)





## General Setup

### Preliminary Inspection

Inspect the transceiver upon opening the packing carton. Check that all controls and switches work freely, and inspect the cabinet for any damage. Ensure the accessory fuses and plugs pictured on page 4 are included. If any damage is found, document it completely, and contact the shipping company (or dealer, if you purchased it over-the-counter) right away. Save the packing materials in case you need to return the set for service. If you have purchased optional internal accessories separately, install them as described on page 99.

### Power Connection

The FT-1000MP can operate from DC voltage, or, if the internal switching PS is installed, directly from the AC mains. For 13.5 V DC operation, see the instructions on page 103.

Before connecting AC power, check the label on the rear panel which indicates the AC mains voltage for which your transceiver is currently set. If the voltage on this label does not match your AC mains voltage, a switch on the internal power supply in the transceiver must be moved, and the fuse must be changed. This requires only a screwdriver and is not difficult (see below), but you should make sure the power supply is set up

### CAUTION

*Permanent damage will result if improper AC supply voltage is applied to the transceiver. Your warranty does not cover damage caused by application of improper supply voltage, or use of an improper fuse.*

correctly before connecting power. If you have any doubts about the procedure, contact your dealer for assistance. We also recommend that you open the fuse holder on the rear panel, and check that the fuse is correct for your mains voltage:

AC Mains Voltage	AC Fuse Rating
100, 110 or 117 V	8 A
200, 220 or 234 C	4 A

After making certain the AC voltage for which the transceiver is set matches your mains voltage, and that the correct fuse is installed in the fuse-holder, connect the AC power cord to the 3-pin AC jack on the rear panel. Wait until all other transceiver interconnections have been made before connecting the other end of the power cord to the wall outlet .

## Changing the Power Supply for Different AC Voltages

- Make certain that all cables are disconnected from the transceiver.
- Remove the three screws from each side of the transceiver, and three from the top edge of the rear panel. Remove the top cover.
- Locate the power supply unit and the voltage selector switch, and move it to the appropriate mains voltage for your country (either 230V or 115V)
- Replace the top cover and its nine screws.

### Internal Power Supply AC Mains Selection

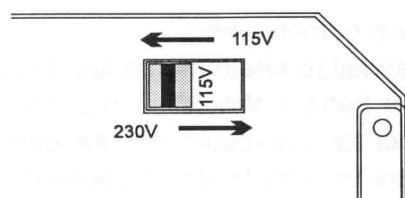

### IMPORTANT!

*If you change the power supply mains voltage, you must change the fuse in the fuse holder, as indicated in text above. Do not use slow-blow type fuses.*

*Also change the voltage marking on the label on the rear panel to match the new voltage setting.*

### Transceiver Location

To assure long life of the components, a primary consideration in setting up the FT-1000MP is providing for adequate ventilation around the cabinet. The cooling system of the FT-1000MP must be free to draw cool air in at the lower rear of the transceiver, and to expel warm air out of the upper rear panel. Do not place the transceiver on top of another heat-generating device such as a linear amplifier, and do not place equipment, books or papers on top of the transceiver. Also, provide a few centimeters of space on either side of the transceiver, if possible. Avoid heating vents and window locations that could expose the transceiver to excessive direct sunlight, especially in hot climates.

### Grounding

For protection from shock and proper performance, connect the **GND** terminal on the rear panel to a good earth ground, using a heavy braided cable of the shortest length possible. All other station equipment should be connected to the same grounding cable, as close together as practical. If you use a computer with or near the FT-1000MP, you may need to experiment with ground wiring to suppress computer noise in the receiver, and ground loops during transmission.

### Adjusting the Front Feet

The two front feet of the FT-1000MP can be set in either of two positions. By turning the knurled ring around a (retracted) foot clockwise, the middle of the foot will extend about one centimeter. Turn the ring as far as it will go (about  $1/4$ -turn) to lock the extended foot in place. To retract an extended foot, turn the knurled ring counterclockwise  $1/4$ -turn while pressing on the center of the foot.

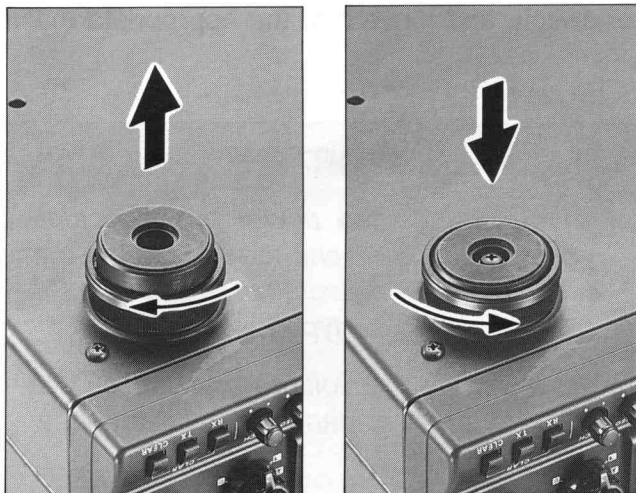

Adjusting the Front Feet

### Antenna Considerations

Any antennas connected to the FT-1000MP should have coaxial feedlines with 50- $\Omega$  impedance, and include a well-grounded lightning arRESTOR. For the antenna connected to the main **ANT A** or **B** jack, the automatic antenna tuner in the FT-1000MP is capable of matching antennas with an SWR of up to 3:1 or more on the amateur bands to the transmitter. Nevertheless, optimum performance for both reception and transmission will generally result with an antenna designed to provide a 50- $\Omega$  unbalanced resistive load at the operating frequency. An antenna that is not designed for resonance at the operating frequency may present too high an SWR to allow proper matching with the built-in antenna tuner, in which case the antenna itself should be readjusted, or an outboard antenna tuner used.

If the tuner is unable to bring the SWR down to an acceptable level, attempting to transmit will result in an automatic reduction in power output and increased losses in the feedline. Operation under such conditions is not recommended: it is better to install another antenna designed for that band. Also, if your antenna has a balanced feed-point and you use a balanced feedline, install a balun between the feedline and the **ANT A** or **B** jack of the transceiver.

The same precautions apply to any additional (receive-only) antennas connected to the **RX ANT** jack, except that neither of these antennas will have the benefit of the built-in antenna tuner. Therefore, unless such receive-only antennas have an impedance near 50  $\Omega$  at the operating frequency, you may need to install an external antenna tuner to obtain optimum performance.

### Memory Backup

The lithium memory **BACKUP** switch on the rear panel is turned on at the factory, allowing VFO and memory data to be retained while power is off. Backup current is miniscule, so it is not necessary to turn the **BACKUP** switch off unless the transceiver is to be stored for an extended period.

After five or more years of operation the transceiver may fail to retain memories, at which time the lithium battery should be replaced. Contact your dealer for replacement of the battery, or for instructions on how to do so yourself, see page 101.

## Front Panel Controls (left side)

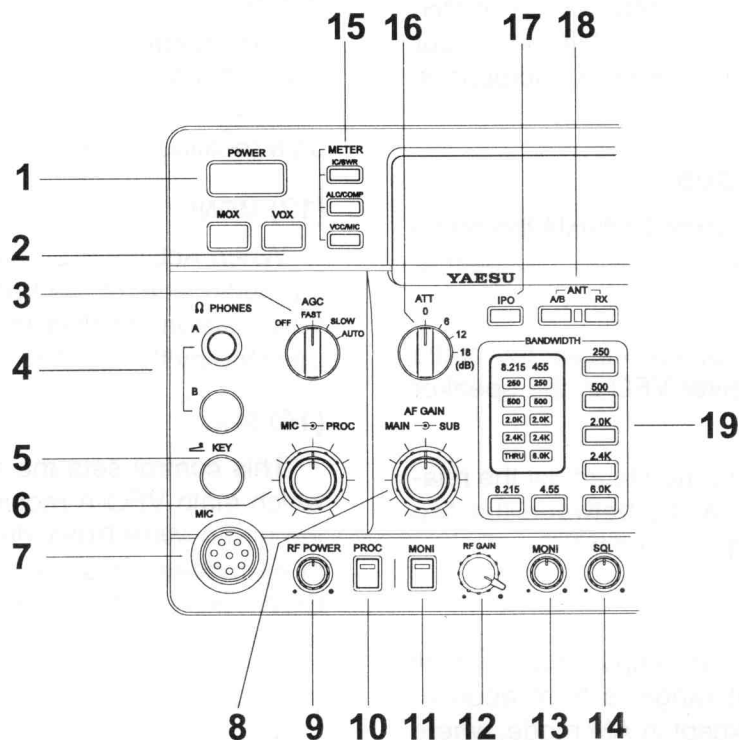

This chapter describes each control and connector on the FT-1000MP. You can just glance through it quickly now, but some of the descriptions will be more meaningful if you take the time to read them in detail now. If questions arise later while proceeding through the operation chapter, you can return to this chapter with the set powered up for control knob clarification. Some controls and switches are disabled under certain conditions.

**(1) POWER**

This button turns the transceiver on and off.

**(2) MOX & VOX Pushbutton Switches**

**MOX** may be used in place of a microphone PTT switch or CW key to activate the transmitter, when depressed. It must be in the undepressed position for reception.

**VOX** enables automatic voice-actuated transmitter switching in SSB, AM and FM modes, and "semi-break-in" keying in CW mode. The controls affecting VOX operation are located in the top access panel.

**(3) AGC Selector**

Selects main receiver Automatic Gain Control decay time for most comfortable reception, or disables receiver AGC (off). Normally this switch is set to the **AUTO** position. Strong signals will cause distortion if this selector is set to **OFF**.

**(4) PHONES**

A 1/4 inch and 3.5 mm, 3-contact jack accept either monaural or stereo headphones with a 2- or 3-contact plug. When a plug is inserted, the loudspeaker is disabled. With stereo headphones such as the optional YH-77STA, you can monitor both receiver channels at the same time during dual reception. In this case, the headphone **HP** controls (page 18) beneath the top access panel adjust levels mixed, separate or monaural headphone operation.

**(5) KEY**

This 1/4-inch, 3-contact jack accepts a CW key or keyer paddles (for the built-in electronic keyer), or output from an external electronic keyer. *You cannot use a 2-contact plug in this jack.* Pinout is shown on page 4. Key up voltage is 5 V, and key down current is 0.5 mA. There is another jack with the same name, connected in parallel with this jack, on the rear panel.

**(6) MIC ↔ PROC**

The inner **MIC** control adjusts the microphone input level for (non-processed) SSB and AM transmission.

The outer **PROC** control sets the compression (input) level of the transmitter RF speech processor in SSB modes, when activated by the button with the same name.

### (7) MIC

This 8-pin jack accepts the MD-100A8X or MH-31B8 Scanning Hand Microphone. MIC connector pinout is shown on page 4. Proper microphone input impedance is 500 ~ 600  $\Omega$ .

### (8) AF GAIN MAIN ↔ SUB

The inner **MAIN** gain control adjusts the audio volume of the MAIN receiver VFO in the speaker or headphones.

The outer **SUB** gain control adjusts the audio volume of the SUB receiver VFO in the speaker or headphones.

Both controls can be rotated to adjust the relative balance of receiver audio between the two receiver channels during dual reception.

### (9) RF PWR

This adjusts transmitter output power in all modes. The adjustment range is from approximately 5 ~ 100 watts, except in AM mode, where it is about 5 ~ 25 watts. This controls the carrier level for CW and AM transmission. Also, when the speech processor is used in the SSB modes, this control sets the processor level. In each case, the ALC function of the meter should always be selected when setting this control, to avoid overdriving the transmitter final amplifier.

### (10) PROC

This button enables the RF speech processor for SSB transmission. Processing level is set by the outer control with the same name. While activated, the LED in this button glows green.

### (11) MONI

This orange button enables the transmit (RF) monitor in all modes (except CW, in which the monitor function is always on, to produce the sidetone). While activated, the LED in this button glows green.

### (12) RF GAIN

The **RF** gain control adjusts the receiver signal level in front of the main receiver 1st mixer (via PIN diodes), and also the gain of the main receiver IF amplifiers.

It is normally set fully clockwise for maximum sensitivity. When rotated CCW, the S-meter minimum deflection point will move up the scale. The peak deflection for a particular signal will remain the same if it is greater than the level set by this

control, but the main receiver will be insensitive to weaker signals.

This control also affects the **SQL** setting for main VFO-A, and should be preset fully clockwise when setting the squelch threshold for the VFO or on a recalled memory.

### (13) MONI

When activated by the **MONI** button (above), the audio level of the transmit RF monitor during transmission (relative to the **AF GAIN** control) is adjusted by this control.

### (14) SQL

This control sets the signal level threshold at which main VFO-A receiver audio is muted (and the green **MAIN BUSY** display indicator turns off), in all modes. This control is normally kept fully CCW, except when scanning and during FM operation.

### (15) METER Selector Switches

These determine the function of the multifunction meter during transmission. The meanings of the abbreviations are as follows:

**IC/SWR** - Final amplifier collector current (Amps) and Standing Wave Ratio (forward:reflected).

**ALC/COMP** - relative Automatic Level Control voltage and RF speech compressor level (in dB, for SSB modes only).

**VCC/MIC** - Final amplifier collector voltage and microphone gain input level.

The meter indicates power output and the selected parameter during transmission, and signal strength in S-units during reception (on the main receiver). Each S-unit is approximately 6 dB.

### (16) ATT

This inserts 6, 12, or 18 dB (1, 2, or 3 S-units) of attenuation before the mixer to suppress band noise and possible overload from very strong signals.

### (17) IPO

Press this to set optimum receiver front end characteristics for strong signals. This bypasses the front end RF amplifier and feeds the received signals directly to the first mixer.

### (18) ANT A/B RX

**A/B** - pressing this selects either the **ANT A** or **B** jack on the rear panel, and allows convenient antenna switching at the press of a button. The

selected antenna jack is also indicated at the top of the display (above the channel group number).

**RX** - normally, the antenna connected to the **ANT A** or **B** jack is used for receive (and always used for transmit). When this switch is pressed (display indicator on), an antenna connected to the **RX ANT** is used during receive.

**(19) BANDWIDTH**

**(A)** Selectivity Indicators - these light to show the selected filter configuration/combinations for the 2nd and 3rd IF.

**(B)** **8.215** and **455** - pressing these select either the 2nd IF filter bank (8.215 MHz) or 3rd IF filter bank (455 kHz) for individual filter selection within that bank.

**(C)** **250**, **500**, **2.0K**, **2.4K**, and **6.0K**

These five momentary buttons select the 2nd and 3rd IF filters for the receiver (except in the FM mode). In AM mode, either 2.4-kHz or 6-kHz bandwidth is selected by pressing the **2.4K** or **6.0K** button. The selectivity provided by these selections can be further enhanced by installing optional filters (page 100). See the diagram on page 32 for the available filter combinations.

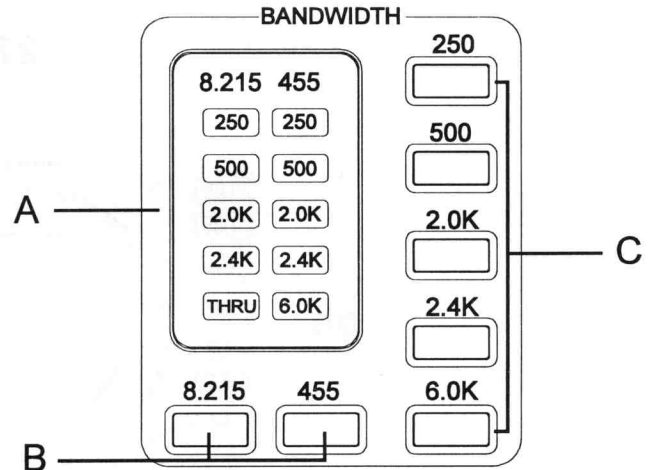

**Note** - The Sub Receiver use a double-conversion circuit with 47.21 MHz and 455 kHz intermediate frequencies. Both 6.0 K and 2.4 K filters are selected automatically according to mode, and with the optional 500-Hz Collins mechanical filter (Yaesu P/N YF-115C) installed and enabled via menu programming, it can be selected for CW operation.

## Front Panel Controls (center)

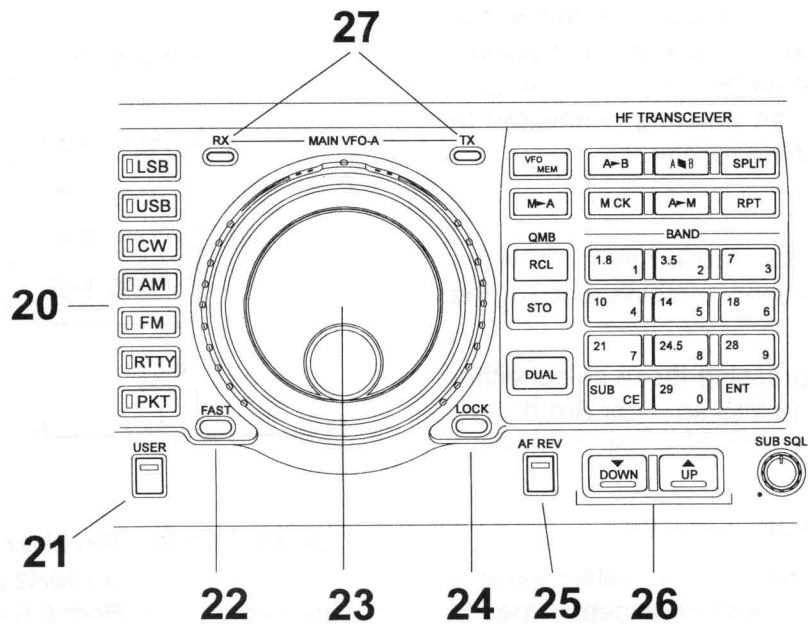

### (20) Mode Selection

These momentary buttons select the operating mode, indicated by the LED in each button. Pressing **AM**, **CW**, **RTTY**, or **PKT** multiple times will switch between the alternate operating features that can be used by these modes (covered later).

### (21) USER

This button activates the user-programmed custom function setting (explained in detail on page 63). When activated, the LED inside this button glows green.

### (22) FAST

For fast tuning, press and hold this button while rotating the main or sub tuning knobs or pressing the **UP** or **DOWN** button to increase the tuning rate ten times. See the table on page 25 for all available steps.

### (23) Main VFO-A Knob & Shuttle Jog

The large knob adjusts the operating frequency of Main VFO-A or a recalled memory. Tuning increments are normally 10 Hz (100 Hz in AM and FM modes). When the **FAST** button is held, the increments are 10x these sizes.

The outer concentric shuttle jog allows fine or rapid frequency excursions with just a slight turn of your hand. Rotating the ring slightly to either the left or right tunes up or down a few steps. The tuning rate increases the farther the ring is rotated.

### (24) LOCK

This button toggles locking of the main tuning knob to prevent accidental frequency changes. **LOCK** is displayed in a red box below and to the left of the main frequency when active (the knob can still be turned, but it does nothing). Press again to enable the tuning knob.

### (25) AF REV

Pressing this reverses the main/sub receiver audio adjusted using the **MAIN** ↔ **SUB** knobs on the **AF GAIN** control. When activated, the LED inside this button glows green.

### (26) DOWN & UP

Pressing either of these buttons momentarily steps the operating frequency down or up 100 kHz, respectively. Pressing and holding the **FAST** button while pressing one of these buttons steps down or up 1 MHz. Continue holding either button for repeated stepping.

### (27) MAIN VFO-A RX & TX Switch-LED

These combination lamp-switches select and indicate the transmit/receive status of the main tuning knob and display. When the green **RX** lamp is lit, the receiving frequency is under control of the main knob and display (either VFO-A or a recalled memory channel). When the red **TX** lamp is lit, the transmitting frequency is under control of the main knob and display.

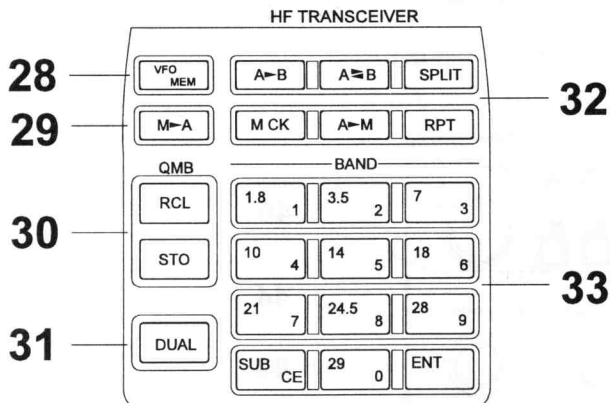

**(28) VFO/MEM**

This button toggles main receiver operation between the memory channel and the main VFO (A). Either **VFO**, **MEM**, or **M TUNE** is displayed to the left of the main frequency display to indicate the current selection. If a displayed memory has been retuned, pressing this button returns the display to the original memory contents, and pressing it again returns operation to the Main VFO.

**(29) M-A**

Pressing this button momentarily displays the contents of the currently-selected memory channel for three seconds. Holding this button for 1/2-second copies the data from the currently selected memory to the Main VFO (A), as two beeps sound. Previous data in the Main VFO is overwritten.

**(30) QMB**

**RECALL** - recalls one of up to five Quick Memory Bank memories for operation.

**STORE** - pressing this copies operating parameters into consecutive QMB Memories.

**(31) DUAL**

This button activates dual-channel reception with the main and sub receivers. When this function is active, **DUAL** is displayed in a box at the left edge of the display.

**(32) VFO & Memory Control**

**A-B**

This button transfers data from the main display (either Main VFO-A or a recalled memory channel) to Sub VFO-B, overwriting any previous contents in the Sub VFO. Use this key to set both Main and Sub Receivers to the same frequency and mode.

**A=B**

This button exchanges the contents of Main VFO-A (or a recalled memory channel), and Sub VFO-B. No data is lost.

**SPLIT**

This activates split frequency operation between the main display (either Main VFO-A or a recalled memory channel), used for transmission, and Sub VFO-B, for reception. The **SPLIT** indicator on the display is lit while this function is active.

**M CK (Memory Check)**

This displays the contents of memory channels without disturbing operation. When pressed, **MCK** is displayed above the channel number and each memory channel can then be checked on the Sub Receiver display by rotating the **MEM** selector. Empty memory channels display as two decimals, with no frequency digits. Press this button again to cancel memory checking.

**A-M**

Pressing and holding this for 1/2 second copies the current operating data from Main VFO-A, or a recalled memory, to the currently selected memory channel, overwriting any previous data stored there. Also, pressing and holding this button after recalling a memory, without first retuning, causes the memory channel to be "blanked," and repeating the process restores the blanked memory.

**RPT**

For 29 MHz FM operation, this button activates standard HF FM repeater offset. Pressing **RPT** once or twice while receiving causes the transmit frequency to be shifted 100 kHz below or above the receiving frequency, respectively. A selectable CTCSS subaudible tone is also transmitted automatically when using this feature, to allow access to repeaters that require it. Pressing **RPT** a third time cancels repeater shift operation.

**(33) BAND (Keypad)**

The keypad provides one-touch band selection, or digital frequency entry. Normally, pressing one of the ten *white* numbered keys selects the corresponding (MHz) amateur band for operation (and pressing the **SUB** button first and then another key selects the band for the Sub VFO). However, if the **ENT** key is pressed first, the *yellow* labels on the keys become effective, for entering any frequency one digit at a time. If you press the white numbered key for the band your are already on, you will select the alternate subband VFO on that band. See the Operation chapter for details.

## Front Panel Controls (right)

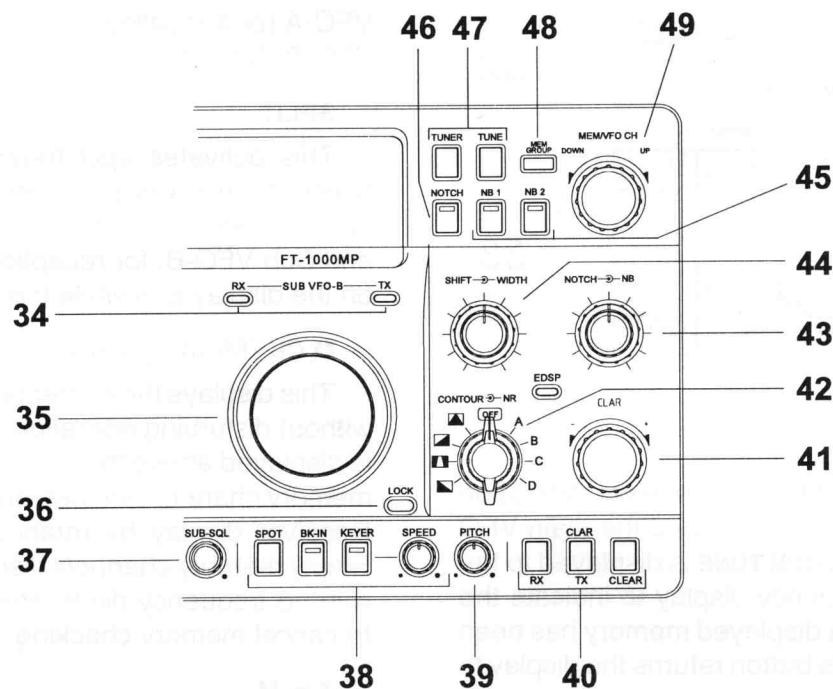

### (34) SUB VFO-B RX & TX LEDs

These lamps select and indicate the current status of SUB VFO-B. When the green **RX** lamp is lit, the receiving frequency is under control of SUB VFO-B. When the red **TX** lamp is lit, the transmitting frequency is under control of SUB VFO-B. During dual receive operation, the green **RX** lamps above both tuning knobs are lit.

### (35) SUB VFO-B Tuning Knob

This knob adjusts the SUB VFO-B operating frequency. Tuning increments are the same as described for the main tuning knob.

### (36) LOCK

This button toggles locking of SUB VFO-B tuning to prevent accidental frequency changes. The red indicator in the display glows when active (the knob can still be turned, but it does nothing). Press the button again to re-enable the tuning knob.

### (37) SUB SQL

This separate control sets the signal level threshold at which SUB VFO-B receiver audio is muted (and the green **SUB BUSY** display indicator turns off), in all modes. This control is normally kept fully CCW, except when scanning and during FM operation.

### (38) CW and Electronic Keyer Controls

**SPOT** turns the CW receiver spotting heterodyne oscillator on and off. **BK-IN** turns full break-in (QSK) CW operation on and off. **KEYER** toggles the internal CW keyer on/off, as indicated by the LED above this button. The **SPEED** control is for speed adjustment of the keyer/bug simulator.

### (39) PITCH Control

Rotate this to select your desired CW tone pitch (from 300~1050 Hz, in 50 Hz increments), as shown in the display. The Tx sidetone, receiver IF passband, and display offset from the BFO (carrier) frequency are all affected.

### (40) CLAR Pushbuttons

Pressing the **RX** button activates the **CLAR** knob, to allow offsetting the receiving frequency temporarily (see item 41 below). The **TX** button provides the same function for the transmit frequency. If both buttons are pressed, the receiver and transmitter are both offset from the original frequency. Pressing the **CLEAR** zeroes any offset tuned by the **CLAR** knob. Each memory and VFO retains all clarifier settings independently.

### (41) CLAR

This knob tunes the clarifier offset frequency up to 9.99 kHz when activated by the **CLAR RX TX** buttons just below it (the 3-digit display appears in the center of the display (if enabled) when the clarifier is active).



**(42) CONTOUR ⇄ NR**

When activated by pressing the EDSP button above these knobs, the outer **CONTOUR** control selects one of four EDSP bandpass filters, while the inner **NR** control selects one of four EDSP noise reduction settings.

**(43) NOTCH ⇄ NB**

These controls are only active when their functions have been enabled by the corresponding buttons above and to their left. The inner **NOTCH** control adjusts the IF notch frequency. The outer **NB** control adjusts the noise blanking level when the noise blanker is activated by pressing either **NB1** or **NB2**.

**(44) SHIFT ⇄ WIDTH**

These controls tailor the Main receiver IF passband, or a recalled memory channel, in all modes except FM. The inner **SHIFT** control offsets the center frequency of the IF passband from the displayed frequency when rotated from center. The outer **WIDTH** control, when turned from center, reduces the overall IF bandwidth from either the lower or upper side, from the maximum selected by the **BANDWIDTH** buttons.

**(45) NB1 NB2**

These activate the Main receiver noise blankers. Press **NB1** to blank short-duration pulses or **NB2** to blank longer duration pulses. The LEDs inside each button glow green while activated. Blanking level for both buttons is adjusted with the outer **NB** knob.

**(46) NOTCH**

This activates the IF notch filter for the main receiver. The frequency of the notch is set by the control with the same name. The LED in this button glows green while the notch filter is active. The notch filter does not affect the Sub Receiver.

**(47) Automatic Antenna Tuner Unit Controls**

**TUNER Pushbutton**

Pressing this button so that its LED is lit places the antenna tuner in line between the transmitter final amplifier and the main antenna jack. Reception is not affected. The tuner is also activated when the **TUNE** button (below) is pressed.

**TUNE Momentary Pushbutton**

Pressing this button while receiving in an amateur band activates the transmitter for a few seconds while the automatic antenna tuner

rematches the antenna for minimum SWR. The resulting settings are automatically stored in one of the antenna tuner's 39 memories, for instant automatic recall later when the receiver is tuned near the same frequency.

**(48) MEM GROUP**

When more than one memory group has been enabled, pressing this limits selection and scanning to those memories within the selected group.

**(49) MEM/VFO CHANNEL**

This detented knob selects the operating memory channel when the memories are active (but not retuned). When the VFO or memory tune functions of the main display are active, turning this knob causes the Sub VFO display to temporarily show the frequencies of the memories (memory check), without otherwise affecting operation. The channel number of the selected memory is displayed at all times at the center right of the display (in front of "CH").

**LCD Bargraph Meter Indications**

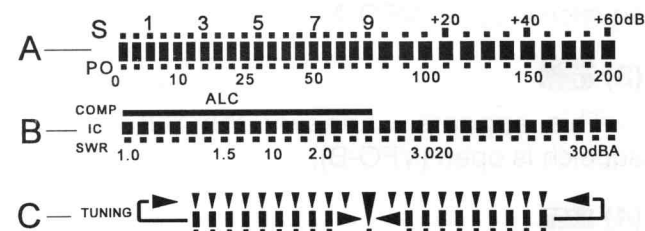

**(A) S/PO Scale**

Thirty-one bargraph segments indicate relative signal strength (one S-unit = 6 dB) from 0 to +60 dB or else RF power output from 0 to 200 Watts (100 watts maximum output available).

**(B) IC/SWR/ALC/COMP Scale**

Indicates final amplifier collector current (IC) from 0 to 30 amps, standing wave ratio (SWR) from 1.0 to 3.0, speech compression from 0 to 30 dB, ALC automatic level control operating range (in red), DC supply voltage level, or microphone audio input level.

**(C) Tuning Scale**

This multi-function tuning scale provides a center tuning segment for zero beating CW stations, and twin bars ("goal posts") for accurate tuning of mark and space tones associated with digital modes, such as RTTY, Packet, and AMTOR.

## Main Receiver Display Indications

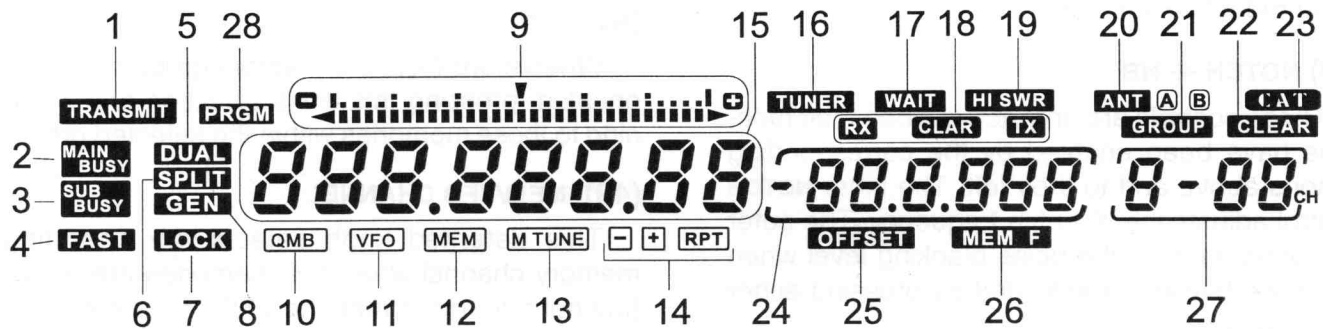

**(1) TRANSMIT**

This appears when the PTT is keyed and transmission is occurring.

**(2) MAIN BUSY**

This appears whenever the Main receiver squelch is open (VFO-A).

**(3) SUB BUSY**

This appears whenever the Sub receiver squelch is open (VFO-B).

**(4) FAST**

Fast VFO tuning rate is active.

**(5) DUAL**

This indicates that dual-receive operation is activated.

**(6) SPLIT**

This indicator appears whenever split-frequency operation is activated (by pressing the SPLIT button).

**(7) LOCK**

Front panel tuning knob and/or buttons are locked.

**(8) GEN**

This appears whenever general coverage tuning is selected (when tuning outside an amateur band).

**(9) Tuning Offset Scale**

Displays sub-resolution tuning steps or clarifier offset in segmented increments.

**(10) QMB (Quick Memory Bank)**

Indicates stored memories from the Quick Memory Bank are active for recall and operation.

**(11) VFO**

VFO tuning or VFO operation is selected.

**(12) MEM**

This indicator shows that memory operation is selected (by pressing **VFO MEM**).

**(13) MTUNE**

Appears while retuning a selected memory channel.

**(14) -RPT+**

One of these segments lights along with the **RPT** indicator when the repeater function is activated in the FM mode, indicating the direction of TX offset.

**(15) Frequency Display**

This displays the current operating frequency, and also provides alphanumeric character display of programming menu selections and settings.

**(16) TUNER**

This indicator comes on when the ATU is activated and in-line.

**(17) WAIT**

Appears when the ATU is seeking the best impedance match with the antenna. It also flashes each time the transceiver microprocessor sends frequency update data to the ATU microprocessor (while you tune).

**(18) RX CLAR TX**

These appear indicating the selected clarifier function (Rx, Tx or both). The clarifier offset frequency ( $\pm 9.99$  kHz) is shown in the sub-display immediately to the right.

**(19) HISWR**

Appears when an abnormally high SWR condition exists that cannot be matched below 3.0:1.

**(20) ANT A B**

Indicates the antenna selected for operation (A or B) by the front panel ANT A/B switch (see item 18 on pages 10~11).

**(21) GROUP**

When the MEM GROUP button is pressed, this indicates memory recall, and scanning is limited to those memories in the currently selected group.

**(22) CLEAR**

Indicates the selected memory channel is not yet filled with data.

**(23) CAT**

External computer control of the transceiver is active.

**(24) Multi-Display Window**

Displays either the clarifier offset, memory channel frequency, split frequency offset, or CW pitch.



Clarifier Offset



M CH Frequency



Split Offset (VFO A - VFO B)

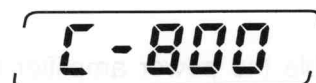

CW Pitch (carrier offset)

**(25) OFFSET**

When enabled, shows the frequency difference (split offset) between Main VFO-A and Sub VFO-B.

**(26) MEM F**

Appears when the memory channel frequency appears in the multi-display panel.

**(27) Memory Channel Box**

During normal operation, the currently-selected memory group and memory channel number appear here. With the Menu Programming mode active, menu selection numbers are displayed.

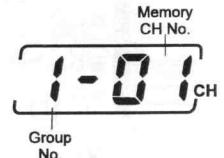

**(28) PRGM**

Appears while tuning within programmed frequency limits in the PMS (Programmed Memory Scan) mode.

**Sub Receiver Display Indications**

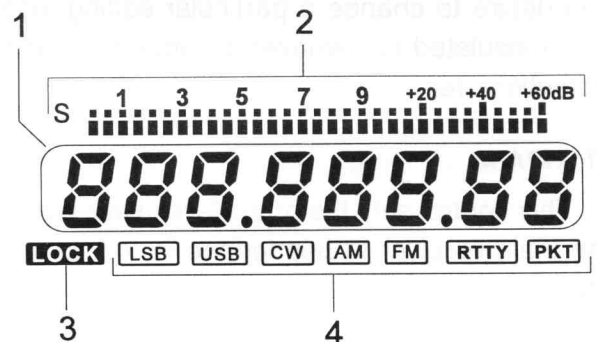

**(1) Frequency Display**

Displays the current sub-receiver frequency used during dual receive operation, and the transmit frequency during split operation.

**(2) S-Meter**

Displays relative signal strength.

**(3) LOCK**

Appears when the Sub VFO tuning knob is disabled (it still turns but does nothing).

**(4) MODE**

Displays the currently-selected operating mode for the Sub receiver.

## Top Panel Access & Controls

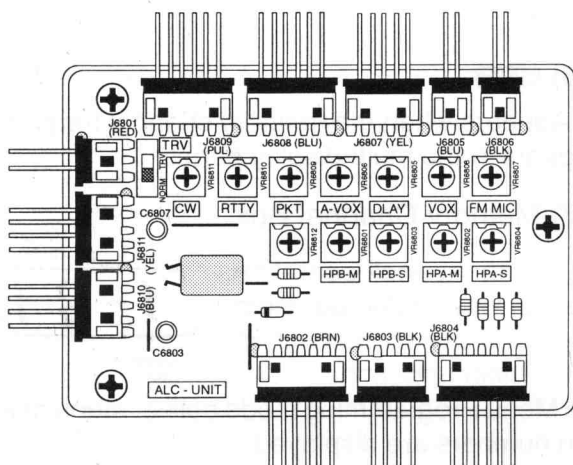

The following controls are accessible beneath the removable panel on the top half of the transceiver case. Push the slide rearward and pry up the lid to expose the ALC UNIT circuit board and potentiometer controls. Most control settings are preset at the factory for normal operation. Should you desire to change a particular setting, use a small insulated screwdriver to rotate the desired potentiometer.

### (1) HPA-M

This control sets the audio level available from the main receiver to headphone jack A (3.5 mm plug).

### (2) HPA-S

This control sets the audio level available from the sub receiver to headphone jack A (3.5 mm plug).

### (3) HPB-M

This control sets the audio level available from the main receiver to headphone jack B (1/4-inc h plug).

### (4) HPB-S

This control sets the audio level available from the sub receiver to headphone jack B (1/4-inc h plug).

### (5) CW

This control adjusts the tuning meter segment indications for CW center tuning.

### (6) RTTY

This control adjusts the tuning meter segment indications for RTTY center tuning.

### (7) PKT

This control adjusts the tuning meter segment indications for Packet center tuning.

### (8) A-VOX (ANTI-VOX TRIP)

This control sets the level of negative feedback of receiver audio to the microphone, to prevent receiver audio from activating the transmitter (via the microphone) during VOX (voice-actuated transmit/receive switching) operation. Adjustment is described in the Operation chapter.

### (9) DLAY (VOX Delay)

This control sets the hang time of the VOX circuit, between the moment you stop speaking, and the automatic switch from transmit back to receive. Adjust this for smooth VOX so the receiver is only activated when you want to listen.

### (10) VOX

This control sets the gain of the VOX circuit, to set the level of microphone audio needed to activate the transmitter during voice operation while the VOX button on the front panel is depressed.

### (11) FM MIC

During FM operation, this control adjusts the microphone gain (and transmitter deviation). More clockwise settings produce a wider bandwidth signal.

**NOTE:** This control has been preset at the factory to produce the correct deviation with standard microphone levels. A deviation meter should be connected for proper readjustment, as it is difficult to determine the proper setting by ear.

### (12) TRV

To disable the power amplifier when you are using a transverter, move this switch to the "TRV" position.

## Rear Panel Controls & Connectors

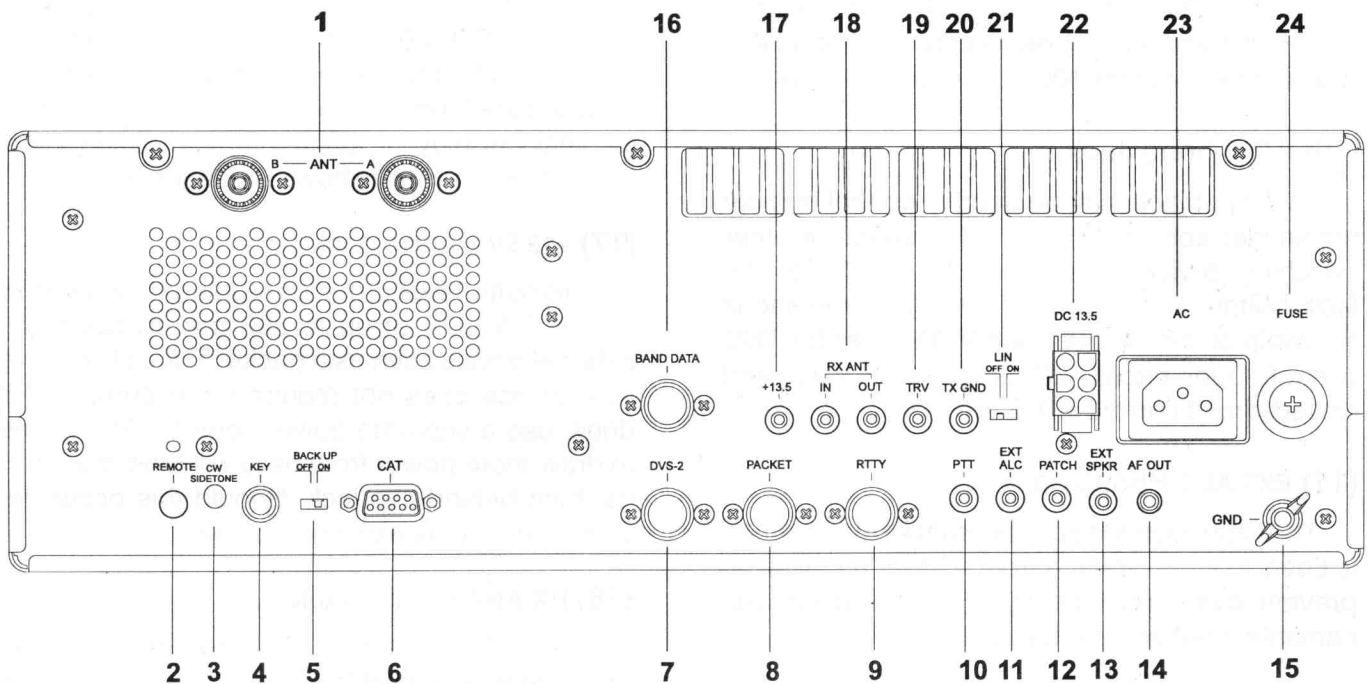

### (1) ANT Coaxial Jack

Connect your main antenna here, using a type-M (UHF, PL-259) plug and coaxial feedline. This antenna is always used for transmission, and is also used for reception unless a separate receive antenna is also used for the main receiver. The internal antenna tuner affects *only* the antenna connected here, during transmission.

### (2) REMOTE Jack

By plugging in a remote control keypad here, direct access to the FT-1000MP CPU is provided for control functions such as contest memory keying, frequency, and functions control.

### (3) CW SIDETONE Control

Insert a small insulated screwdriver here and turn the trimmer inside to adjust the volume of the side tone heard when the **SPOT** button or CW key is pressed.

### (4) KEY 3-Contact Phone Jack

This 1/4-inch phone jack accepts a CW key or paddle manipulator. It is connected in parallel with the jack with the same name on the front panel (either or both may be used). A 2-contact plug *cannot be used in this jack*. Keyup voltage is +5 V, and keydown current is 0.5 mA. Plug wiring is shown on page 4.

### (5) BACKUP Slide Switch

Keep this switch in the **ON** position to retain all memory and VFO settings during power-off periods. There is no need to turn this switch off unless you plan to store the transceiver for a long period without use.

### (6) CAT Serial DB-9 Jack

This 9-pin serial DB-9 jack allows external computer control of the FT-1000MP. Connect a serial cable here and to the RS-232C COM port on your personal computer. CAT command protocol and data formats are described in the CAT chapter, starting on page 73.

### (7) DVS-2 DIN Jack

This 7-pin input/output jack is for connection of the DVS-2 Digital Voice Recorder option, described on page 64.

### (8) PACKET DIN Jack

This 5-pin input/output jack provides receiver audio and squelch signals, and accepts transmit (AFSK) audio and PTT control, from an external Packet TNC. Pinout is shown on page 53. The receiver audio level at this jack is approximately 100 mV (@600Ω), preset by VR3010 on the AF Unit (see page 53 for how to gain access to this trimmer, if necessary).

### (9) RTTY DIN Jack

This 4-pin input/output jack provides connections for an RTTY terminal unit. Pinout is shown on pages 4 and 53. The receiver audio level at this jack is at a constant 100-mV (@600  $\Omega$ ) level.

### (10) PTT Phono Jack

This input jack may be used to control manual transmitter activation using a footswitch or other switching device. Its function is identical to the **MOX** button on the front panel. The same line is available at the **PACKET** and **RTTY** jacks for TNC control. Open-circuit voltage is +13.5 VDC, and closed-circuit current is 1.5 mA.

### (11) EXT ALC Phono Jack

This input jack accepts external ALC (Automatic Level Control) voltage from a linear amplifier, to prevent over-excitation by the transceiver. Acceptable input voltage range is 0 to -4 VDC.

### (12) PATCH Phono Jack

This input jack accepts transmitter audio – either AFSK or voice, for transmission. This line is mixed with the microphone audio input line, so the microphone should be disconnected if using this jack and mixing is not desired. Impedance is 500 – 600  $\Omega$ .

### (13) EXT SPKR Mini Phone Jack

This 2-contact output jack provides mixed receiver audio for an external loudspeaker, such as the SP-8. Inserting a plug into this jack disables the internal loudspeaker. Impedance is 4 to 8  $\Omega$ .

### (14) AF OUT Mini Phone Jack

This 3-contact jack provides dual-channel low level receiver output, for recording or external amplification. Peak signal level is 200 mVrms at 600  $\Omega$ . Main receiver audio is on the left channel (tip), and sub receiver audio is on the right channel (ring). A stereo amplifier or recorder is recommended, to record each receiver separately when dual reception is enabled. The front panel **AF GAIN** control and the **AF REV** switch setting do *not* affect the signals at this jack.

### (15) GND Terminal Post

Use this terminal to connect the transceiver to a good earth ground, for safety and optimum performance. Use a large diameter, short braided cable.

### (16) BAND DATA DIN Jack

This 8-pin output jack provides control signals for the FL-7000/VL-1000 Solid-State Linear Amplifier or FC-1000 Remote Controlled Antenna Tuner, including band selection data to automatically set the Linear or Tuner to the same band as the main display of the transceiver. Band Data jack connections are shown on pages 4 and 68.

### (17) +13.5V Phono Jack

This output jack provides regulated, *separately fused* 13.5 VDC at up to 200 mA, to power an external device such as a packet TNC. Make sure your device does not require more current (if it does, use a separate power source). Attempting to draw more power from here will blow the internal fuse behind this jack. Should this occur, replace the fuse as explained on page 101.

### (18) RX ANT Phono Jack

This antenna jack is for a separate receive-only antenna, activated when the switch with the same name on the front panel is pressed. An antenna connected here can be used by both the Main and Sub Receivers.

### (19) TRV Transverter Drive Output Jack

This jack provides a low level RF output for use with a transverter. Output is approximately 100 mVrms at 50  $\Omega$ .

### (20) TX GND Phono Jack (normally disabled)

When enabled by the **LIN** switch, this output jack connects inside the FT-1000MP to a set of relay contacts which short together (to chassis ground) whenever the transmitter is active. This allows transmit/receive switching of an external device such as a linear amplifier. This jack is disabled at the factory to avoid the clicking of the relay when it is not used.

### (21) LIN Linear Amplifier Relay Switch

To enable the **TX GND** jack and RX front-end protection when you are connecting an external linear amplifier, move this switch to its ON position.

Maximum ratings for these relay contacts are 500 mA @ 125 VAC, 300 mA @ 220 VDC or 2 A @ 30 VDC. *Before connecting an external device, make sure its switching requirements will not exceed these limits.*

If your amplifier requires higher current, or has higher voltage switching requirements, an external switching device must be used.

**(22) DC 13.5V DC Cable Socket**

This 6-pin molex socket accepts DC input power to the transceiver if the internal switching power supply is not installed, or when AC is not available.

**(23) AC Line Cord Socket**

Connect the supplied AC line cord to this socket after ensuring that your AC mains voltage matches that on the label. See the *Installation* section for instructions on how to change the internal switching power supply AC mains voltage, if necessary.

**(24) FUSE Holder**

This holder requires a 8-A fuse for operation from AC voltages below 125 V, and an 4-A fuse for AC voltages of 200 V and above. Only normal fast-blow type fuses should be used here.

**Additional Note**

The volume of the beep that sounds when a front-panel button is pushed can be adjusted by turning a trimmer accessed via the small hole on the bottom cover of the transceiver.

Insert a small, thin, insulated, flat screwdriver into the hole to adjust VR3001 for the desired beep volume. Beep tone is adjusted via menu programming and discussed later in the manual.

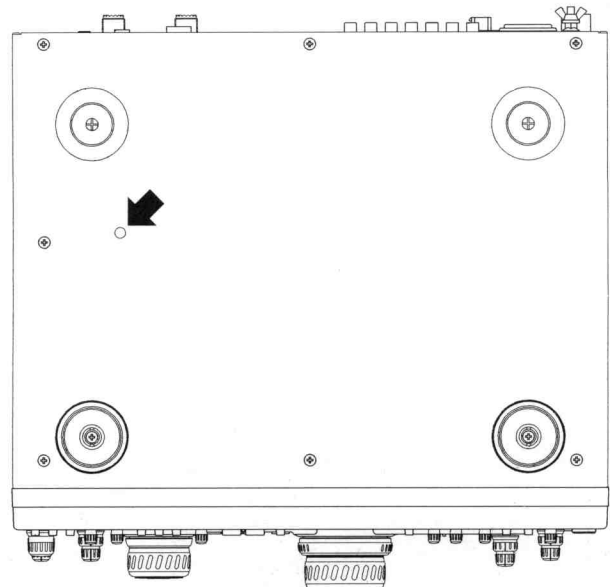

**Notes:**

Additional Note  
The volume of the back that sounds when  
the piston is pushed in  
is the same as the volume of the  
piston when it is pushed in  
the same amount of force  
is applied to the  
piston when it is pushed in  
the same amount of force



## Operation

### Before Starting

Before plugging in the transceiver, check your installation to make sure your AC voltage is correct, and that your ground and antenna are connected as described in the *Installation* chapter. Then preset the following controls as indicated:

**POWER, ANT RX, MOX, VOX, and AF REV** switches all off.

**AGC** selector to **AUTO**

**IPO** switch **OFF**

**AF GAIN MAIN** (inner) and **SUB** (outer) controls matched at approximately 9 o'clock

**MIC, RF PWR, PROC, SQL, SUB SQL, and NB** all counterclockwise

**RF GAIN** fully clockwise

**SHIFT/WIDTH** 12 o'clock (detent)

**LOCK, FAST, SPOT, BK-IN, and KEYER** switches all off.

Connect your microphone and CW key/paddles, then plug the AC cord into the wall outlet.

### FT-1000MP Menu Programming

The FT-1000MP incorporates a wealth of operating functions and features. For flexibility in configuring these capabilities, and to keep the front panel controls to a minimum, an internal *Menu Programming* routine is used. This allows customizing the functions via menu selections that previously required many elaborate DIP switch settings, power-on/button holding routines, or additional front and rear panel controls/switches. This permits each rig to have a custom "personality" that specifically matches your operating requirements, with the capability for easy modification as your requirements change.

Descriptions for most transceiver functions in this chapter assume default (factory-configured) transceiver settings. Menu programming is enabled by pressing the **FAST** button, followed by **ENT**, then rotating the **MEM/VFO CH** knob to display the desired setting. Each of the settings can be changed or customized as you like in this mode. For clarity's sake, transceiver functions that have several settings or options are referenced to the *Menu Programming* chapter separately, where details of programming are covered.

### Receiving

Note: the following procedure assumes the transceiver has not been used before, and not already set for dual reception. If **DUAL** appears on the display when you switch on the set in the next step, you should press the blue **DUAL** button to return to the single-receiver mode (for now).

Press the **POWER** switch on. The meter and display should light up. If the display is too bright for your taste, it can be switched to a subdued level using menu selection 3-4 (see page 87).

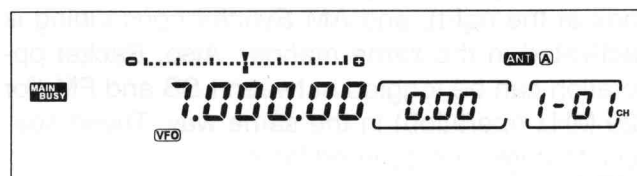

Take a moment to study the display. You should see **VFO** at the bottom, with the operating frequency of the Main VFO just above the main tuning knob. To the right of that is the *clarifier offset* (000), followed by the *memory channel* number (1-01<sub>CH</sub> by default). At the right side of the display are the current mode and frequency of SUB VFO-B, which we'll talk about later.

### Amateur Band Selection

Press a keypad key (between the two tuning knobs) to select a band for which your antenna is designed. Refer to the white "MHz" labels, and press the appropriate one.

BAND					
1.8	1	3.5	2	7	3
10	4	14	5	18	6
21	7	24.5	8	28	9
SUB	CE	29	0	ENT	

### Key Beeper

Pressing a front-panel button normally produces a beep. Its volume is independent of receiver volume, and can be set by adjusting a trimmer via a hole on the bottom panel of the transceiver case.

To change the pitch of the beeper, recall menu selection 4-2 (page 88) and select the desired pitch (between 220 and 7040 Hz) by turning the dial. You can also disable the beeper via menu selection 4-1 (also page 88).

Mode Selection

Press the mode button (to the left of the main tuning knob) corresponding to the mode you wish to operate — for now, we suggest an SSB mode: **USB** if you have selected a band above 10 MHz, or **LSB** otherwise. The green LED in each button indicates the selected band, and an a pair of LEDs within the bandwidth panel (to the left of the mode buttons) indicates which IF filter pair is currently selected for that mode.

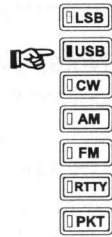

CW and RTTY have “reverse” modes that are selected by pressing their button twice (see the box at the right), and AM *Synchronous* tuning is activated in the same manner. Also, Packet operation can be toggled between LSB and FM (for 29 MHz operation) in the same way. These special features are covered later.

Additionally, notice that the bargraph meter format changes to the appropriate tuning display for the selected mode (covered later).

If you have selected an SSB mode, both **2.4K** LEDs (2nd & 3rd IF) should be lit. If not, press **2.4K**. This bandwidth provides good fidelity for SSB reception and should be used unless QRM from stations on adjacent frequencies becomes a problem (as described later). The selectable bandwidth (filter combination) depends on which optional IF filters you have installed; therefore some combinations may not be possible.

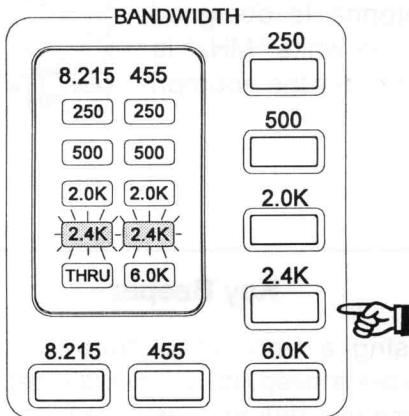

Adjust the **MAIN AF GAIN** (inner) control for comfortable volume on signals or noise in the loudspeaker or headphones. The outer **SUB AF GAIN** control is used with the Sub VFO operation and is explained in greater detail later.

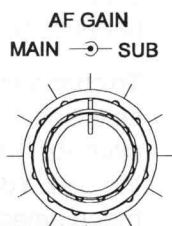

**- Special Note for CW Mode - Reverse CW sideband**

When you switch modes between CW and USB, you may notice that the frequency of received signal stays the same (even though the panel frequency may change slightly). Also notice that the pitch of a received signal decreases as you increase the dial frequency.

However, switching to LSB from CW normally requires retuning the desired station. This can be especially inconvenient if you enjoy working the lower HF bands (40 meters and below) where LSB mode is used.

To eliminate the need for retuning in this situation, you may switch the receiver CW carrier oscillator injection to the reverse side(LSB). When you press **CW**, you should notice that the green LED in the USB mode button blinks for a second or two. This informs you of the default carrier offset (upper) for CW. To switch to lower injection side by simply pressing the CW button again, you should see the displayed frequency shift and the LSB LED blink.

When using the reverse sideband (LSB) for CW reception, you can freely switch between LSB and CW without having to retune a station. Note that in LSB and CW modes the received signal pitch now increases as you increase the dial frequency.

To return the receiver to the default (upper) sideband, simply press **CW** again.

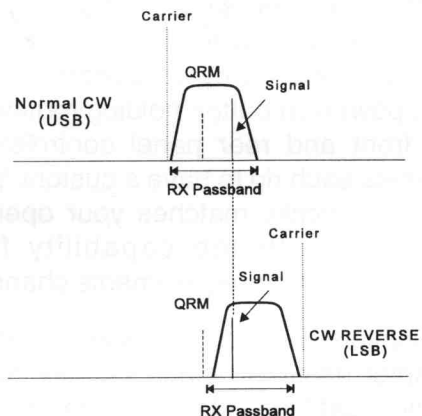

**Operating Hint** - an added benefit from this feature is QRM rejection. If you have interference on a CW station that the IF SHIFT does not eliminate, you can try switching to the reverse sideband, retuning the signal, and trying the IF SHIFT again.

## Tuning the FT-1000MP

Tuning is accomplished several ways, with method each having its own advantages, they are:

- Main & Sub VFO Knob Tuning
- Shuttle Jog Tuning
- Panel & Microphone Down / Up keys
- VFO Channel Stepping

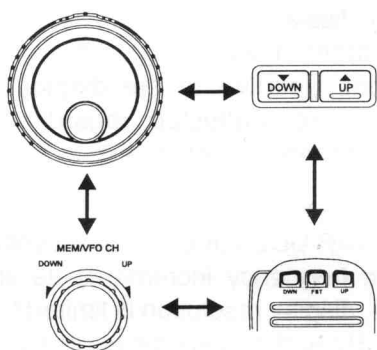

Tuning Methods

### VFO Knob

Rotating the Main VFO-A knob tunes the transceiver according to the selected tuning step size and encoder tuning rate. Both of these settings are configured via menu selections 1-3 & 1-4 (see page 86). The table below shows the available tuning step sizes and their default settings.

Control	Tuning Steps	Default Step
MAIN VFO-A SUB VFO-B	.625 Hz, 1.25 Hz 2.5 Hz, 5 Hz 10 Hz, 20 Hz	10 Hz
Shuttle Jog	13 preset	N/A
DOWN/UP Push buttons (panel & mic.)	Normal	100 kHz
	w / FAST button	1 MHz
MEM/VFO CH Ch. Stepping	Normal	10 kHz
CLAR (clarifier)	.625 Hz, 1.25 Hz 2.5 Hz, 5 Hz 10 Hz, 20 Hz	10 Hz

For faster dial tuning rates with either the VFO knob or mic UP/DOWN buttons, press the **FAST** button below and to the left of the Main VFO knob (**FAST** appears). This selects the VFO speed, which can be switched between 4x (default) and 2x in menu selection 1-0 (see page 86). This affects the  $\Delta F$  per VFO knob rotation without changing the default tuning step size.

Default Tuning Step	QSY ( F ) for 1 revolution of VFO knob			
	( x 2 ) Encoder Rate		( x 4 ) Encoder Rate	
	normal	FAST	normal	FAST
.625 Hz	312 Hz	3.12 kHz	625 Hz	6.25 kHz
1.25 Hz	625 Hz	6.25 kHz	1.25 kHz	12.5 kHz
2.5 Hz	1.25 kHz	12.5 kHz	2.5 kHz	25 kHz
5 Hz	2.5 kHz	25 kHz	5 kHz	50 kHz
10 Hz	5 kHz	50 kHz	10 kHz	100 kHz
20 Hz	10 kHz	100 kHz	20 kHz	200 kHz

### Shuttle Jog

The shuttle jog ring is more efficient for large frequency excursions, or whenever QSY requires spinning the VFO knob a lot, while still providing positive control with a comfortable feel.

Rotating the jog away from the center detent in either direction starts constant tuning. The farther the jog is moved from center, the larger the progressive frequency steps (and QSY). There are 13 preset frequency steps incrementing through the arc of the shuttle jog (from 10 Hz ~ 100 kHz). The shuttle jog speed (encoder rate) is also configurable from 1 ~ 100 msec. via menu selection 1-1 on page 86.

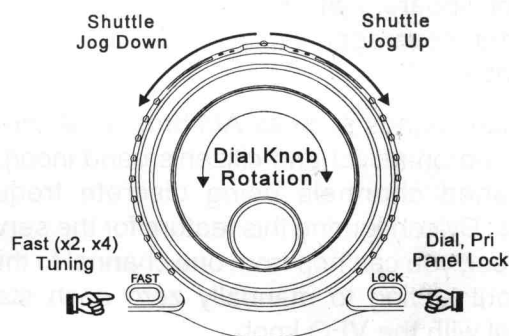

Recall that step size varies as the ring is turned, while encoder rate is fixed. The effect of tuning faster as the ring is rotated actually comes from jumping to progressively larger tuning increments, as encoder rate remains constant.

### FAST Button Operation

By default, the front panel **FAST** button is a press-on, press-off type. However, you can change it to a *momentary* type by recalling menu selection 8-0 (see page 91) and changing the default setting.

## Operation

### Panel Up/Down Buttons

Press the large **UP** and **DOWN** buttons below the keypad to step around the band in 100-kHz steps, and then tune around the band a bit with the tuning knob.

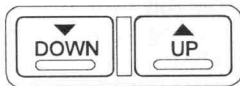

### Microphone Up/Dwn Buttons

If your microphone has **UP** and **DWN** buttons (such as the MH-31B8), you can press them momentarily to tune in 10-Hz steps, or hold them to start VFO scanning. If it has a **FST** button, you can use it to duplicate the function of the **FAST** key on the transceiver front panel.

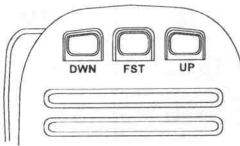

### VFO Channel Stepping

This feature utilizes the **MEM/VFO CH** knob at the upper right corner, and is unique because it allows "channellizing" the VFO for special applications. Basically the VFO frequency steps a discrete value as the **MEM/VFO CH** knob is rotated.

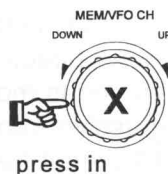

Channel steps for this feature are *variable in 1 kHz steps* from 1 ~ 100 kHz and configured in menu programming. The versatility of this feature is not apparent at first - however, if you enjoy general coverage listening, this capability is invaluable.

Many bands such as AM broadcast, HF maritime, aeronautical and citizen's band incorporate assigned channels using discrete frequency steps. By configuring this feature for the service in interest, you can hop from one channel to the next without having to manually zero each station's signal with the VFO knob.

Channel stepping is activated by first *pressing* the **MEM/VFO CH** knob in, then rotating it as you would to tune. While enabled, "- - -" appears in the channel number display, until the knob is pressed in again to disable channel stepping. Channel stepping is configured by menu selection 1-5 on page 86; also see *General Coverage Reception*.

### Display Settings

**Display Mode** - By default, switching to and from CW, PKT or RTTY modes causes the display to change by the amount of offset selected by the CW PITCH (page 39), RTTY, and PKT tone & offset configurations (pages 53~55). If you prefer the display to remain unchanged when switching modes, this can be done by setting menu selection 3-0 to BFO (carrier) display on page 87. However, the actual carrier offsets configured by the menu selections, relative to the display and IF bandpass are unaffected, regardless of the setting for menu selection 3-0.

**Display Resolution** - Although the FT-1000MP DDS (Direct Digital Synthesizer) tunes in frequency increments as small as .625 Hz, display resolution is limited to 10 Hz. The 10 Hz and 100 Hz digits display can be turned off, as desired, if smaller frequency resolution is not needed (tuning steps are not affected).

Select the desired display resolution via menu selection 3-1 on page 87.

7.000.00	10 Hz Resolution
7.000.0	100 Hz Resolution
7.000	1 kHz Resolution

### VFO & Panel Locking Schemes

The locking scheme for the MAIN VFO-A **LOCK** button offers three choices. By default, pressing the **LOCK** button so that **LOCK** appears only disables the tuning knob (it still turns, but does nothing). However, it can disable *all* front panel keys, or else all *except the primary function keys*. To select the locking scheme, recall menu function 8-1 as shown on page 91.

**Important!** Holding the **LOCK** button without releasing it activates the dual VFO tracking feature, which is discussed later in the chapter.

## Alternate (“Front & Rear”) VFO Operation

If you press the keypad band key for the same band that you are already operating on, the display will shift to a different frequency in the same band (the bottom of the band by default). Pressing the same band key again switches you back to the frequency you were on before. What you have here are two completely independent VFO selections for each band, selectable by each band’s keypad key. You can think of the VFO for every band having a “front” and “rear” half that can be swapped for operation by toggling the band key. You can tune, select a mode and a bandwidth for each of these two VFO halves in each band, and they will be remembered until you return to this “sub receiver” selection.

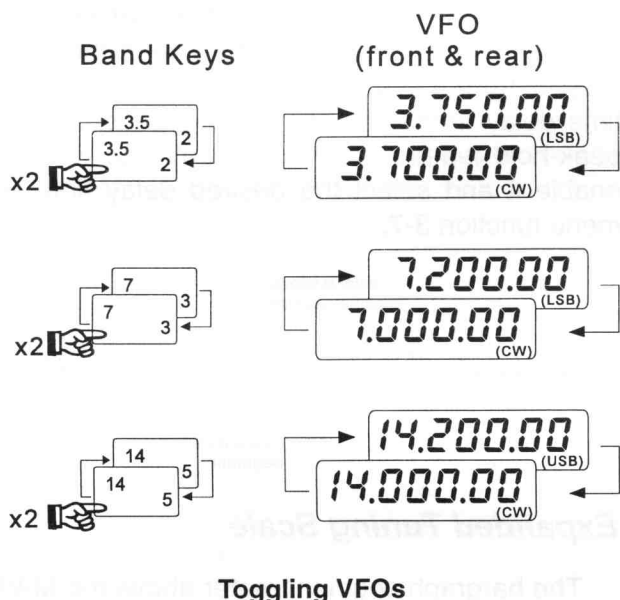

A practical use of this feature is to configure the front VFO for phone operation, and the rear half for CW operation on the same band (see the illustration above).

For example, if one of your VFOs is set to the SSB portion of the band (and in an SSB mode), press the keypad key for that same band, tune to the low end of the band, and press the **CW** mode button. You can consider this your CW VFO. Now press the band key again several times, and notice that operation toggles between the SSB and CW VFO halves. You can also select different IF bandwidths as well as modes for the two halves (and even different clarifier settings). Note that this feature is not related to the MAIN VFO A and SUB VFO B scheme — dual receive and split operation will be covered later.

## VFO Selection & Receiver Muting

Above the Main and Sub VFO knobs are a pair of button/LEDs labeled **RX** & **TX**. The illuminated green **RX** LED indicates the selected VFO receiver, while the red **TX** LED show the VFO controlling the transmit frequency. As we will see later on in dual and split operation, these buttons configure semi-duplex operation as you choose.

You can mute the Main or Sub VFO at any time by pressing the **RX** button/LED above the corresponding VFO knob. The LED blinks while the receiver remains muted; simply press the button again to unmute.

## Keypad Frequency Entry

Frequencies can be entered directly, if desired, as follows:

Press **ENT** at the lower right corner of the keypad (the leftmost operating frequency digit will blink). Then, referring to the yellow numbers on the keypad, enter the digits of the new frequency, from left to right (**1-4-2-5-0-0-0**), followed by **ENT** again. As you enter the numbers, the next digit to be entered will blink on the display. You can use the **DOWN** and **UP** buttons below the keypad to reposition the blinking digit location as desired (but ignore the direction labels on these buttons).

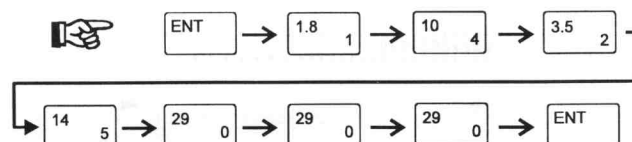

Only when you press **ENT** the second time will the operating frequency actually change, so if you decide to remain on the original frequency after starting to key in a new one, you can cancel any entered digits by pressing **SUB CLR** (“Clear Entry”, the yellow label at the lower left corner of the keypad) instead of **ENT**. Note that, to enter frequencies below 10 MHz, you must key in the leading zeros.

That’s all there is to tuning Main VFO-A. Sub VFO-B has a lot more features of its own, which we’ll look at in detail later. First, however, let’s look at some other important receiver features.

### Signal Tuning Meter Indications

The FT-1000MP incorporates several display indications that make tuning stations a simple and accurate task:

**Tuning Scale** - When either CW, RTTY or PKT operation is selected, the tuning meter appears beneath the IC/SWR meter scale, as shown below.

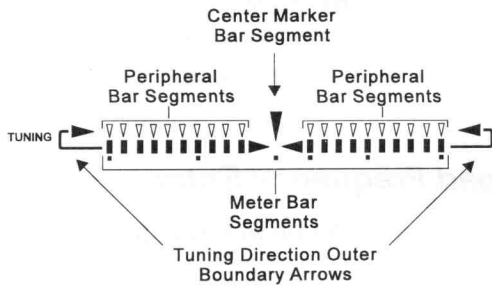

In CW mode, when you tune a signal near the center of the receiver passband, the boundary arrows light, and the upper signal strength segments increase as you slowly tune the VFO knob. The idea is to tune for maximum indication, and so that a lone center marker illuminates in the lower tuning meter (the boundary arrows turn off when the marker is centered). If you detune, the arrows illuminate, indicating to re-center the marker.

#### CW TUNING

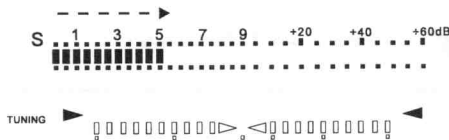

Tune for Maximum Signal Strength and Centered Marker Segment

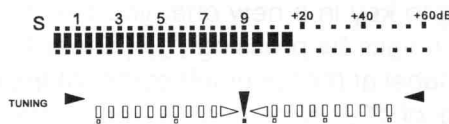

Correctly-Tuned CW Station

For RTTY and Packet, dual segments appear (representing the mark and space tones), and in this case optimum tuning is achieved when even balance and maximum separation between the dual segments occurs. The minimum separation between the segment is proportional to the mark and space tone shift (170 Hz, 425 Hz or 850 Hz) We will cover more about RTTY & Packet operation later.

#### RTTY/PKT TUNING

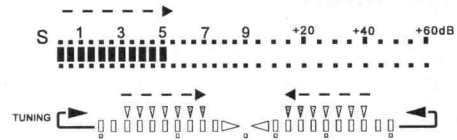

Tune for Maximum Signal Strength and Balanced Marker Pair

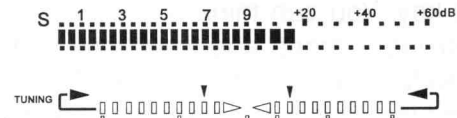

Correctly-Tuned RTTY/PKT Station

**“Peak-Hold” Feature** - During receive, the S-Meter segments respond instantaneously to the relative signal strength (in S-Units) of stations. The meter “peak-hold” circuitry keeps the right-most bargraph segment on for a user-selectable time delay from 10 msec up to 2 seconds. The peak-hold feature is off by default, but you can enable it and select the desired delay time via menu function 3-7.

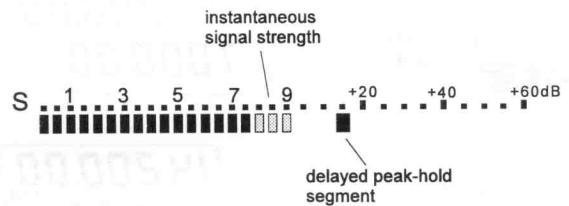

#### Expanded Tuning Scale

The bargraph segment meter above the MAIN VFO-A frequency display serves as a dual mode enhanced tuning scale. By default, it displays relative *clarifier offset*, and as you rotate the CLAR knob (either Rx or Tx clarifier), the normally centered marker segment moves left or right, indicating the relative displaced (“clarified”) Rx or Tx frequency from the original. Be sure to see page 41 for more details on clarifier operation.



Alternately, you can have the segments *expand outwardly* as you tune either direction from the nearest displayed frequency. This lets you view tuning *increments smaller than 10 Hz* (the maximum display resolution).



Expanded Tuning Scale

The rate and distance of segment displacement in either mode are proportional to the selected tuning steps size and if the **FAST** button is engaged. The tuning meter mode is selected by menu selection 3-2.

### AM Synchronous Tuning

Audio distortion of AM stations due to carrier fading is common. Synchronous tuning reduces this phenomenon by receiving the station in LSB while re-injecting an unfading carrier. The benefit of this technique is that the re-injected carrier is phase-locked to carrier of the original station, reducing the effects of fading and improving signal fidelity over that of conventional AM detection.

To activate AM synchronous detection, press the **AM** button *twice* (so the green LED inside the button blinks). The tuning meter format changes to that below. Slowly tune across the signal until the lone center segment appears (see below).

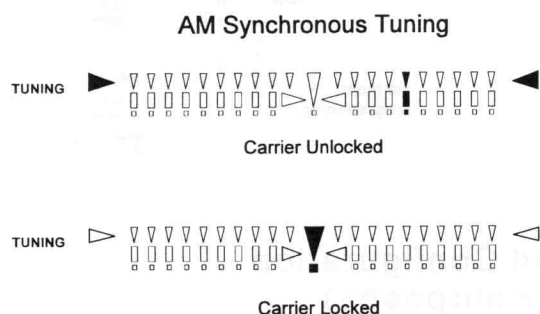

### General Coverage Reception

You may have already noticed that if you tune outside one of the amateur bands (actually, outside of the 500-kHz segment that includes each band), **GEN** appears in a box at the left side of the display. On such frequencies, the transmitter and antenna tuner are disabled. If you try to transmit, **TRANSMIT** will blink.

Also, such frequencies are ignored by the band selection keys (including the alternate sub receiver feature): so if you tune a VFO to a frequency outside of a ham band, you will have to store it in a memory (as described on page 47) if you want to be able to recall it quickly later. Otherwise, as soon as you press a band key, the general coverage frequency will be lost as the VFO reverts to the (ham-band) frequency it was on when the band was last changed.

Once you become familiar with the memories, you will find this really doesn't present a problem, as each memory can be tuned just like a VFO, and stored into another channel without having to go through a VFO.

Aside from the above, general coverage reception provides all of the features available on ham frequencies, including dual channel reception, digital modes, and diversity reception, described on the following pages. A wealth of interesting broadcasts can be found outside the amateur bands, including:

- International Shortwave Bands (see table)
- Maritime & Aeronautical Communications
- News Services & Diplomatic/Embassy Traffic
- Military Communications

Popular Shortwave Broadcast Bands			
Meter Band	Frequency Range (MHz)	Meter Band	Frequency Range (MHz)
LW	.150~.285	31	9.35~9.90
MW	520~1.625	25	11.55~12.05
120	2.30~2.50	22	13.60~13.90
90	3.20~3.40	19	15.10~15.70
75	3.90~4.00	16	17.55~17.90
60	4.75~5.20	-	18.90~19.30
49	5.85~6.20	13	21.45~21.85
41	7.10~7.50	11	25.67~26.10

## Dealing with Interference

The FT-1000MP includes a wide range of special features to suppress the many types of interference that may be encountered on the HF bands. However, real world interference conditions are constantly changing, so optimum setting of the controls is somewhat of an art, requiring familiarity with the types of interference and the subtle effects of some of the controls. Therefore, the following information is provided as general guidelines for typical situations, and a starting point for your own experimentation.

### Front End Selections: Amp Selection, ATT, IPO, & RF GAIN

The best receiver front-end selection will depend on background noise at the time, the presence or absence of strong signals, and whether or not you want to hear very weak signals. If the front end is set for too much gain, background noise will make listening difficult, and very strong signals on other frequencies may cause intermodulation interference, masking weaker signals. On the other hand, if the front end is set for too little gain (or too much attenuation), very weak signals will not be heard.

#### Wide-Band and Tuned Amp Selection

Three high-performance FET RF amplifiers are utilized in the FT-1000MP receiver front end. A flat wide-band amp (factory default) is provided for good general all-around performance along with dual tuned amplifiers: one optimized for 24~30 MHz, the other for 1.8~7 MHz (see illustration). Each amplifier is selected automatically as

you tune or change bands; however, you can disable the tuned amplifier pair and only use the wide-band amp via menu selection 8-4.

#### IPO (Intercept Point Optimization)

Normally, the front-end FET RF amplifiers provide maximum sensitivity for weak signals. During QRM conditions on lower frequencies (such as strong overloading from signals on adjacent frequencies), the RF amplifiers can be bypassed by pressing the **IPO** button so the green LED is on. This improves the dynamic range and IMD (intermodulation distortion) characteristics of the receiver, at a slight reduction of sensitivity.

#### ATT (RF Attenuator)

Even with the IPO function on, very strong signals can still overload the mixer. So if you still notice intermodulation, or if the signals you want to listen to are very strong, you can use the **ATT** selector to insert 6, 12, or 18-dB of RF attenuation in front of the RF amplifier. If background noise causes the S-meter to deflect on clear channels, turn the **ATT** selector clockwise until the S-meter drops below S-1 (the white area at the left end of the top meter scale). This setting optimizes the trade-off between sensitivity and interference immunity. Also, once you have tuned in a station you want to work, you may want to reduce sensitivity further (or add more attenuation) by turning the **ATT** control to a more clockwise setting. This reduces the strength of all signals (and noise) and can make reception more comfortable, important especially during long QSOs.

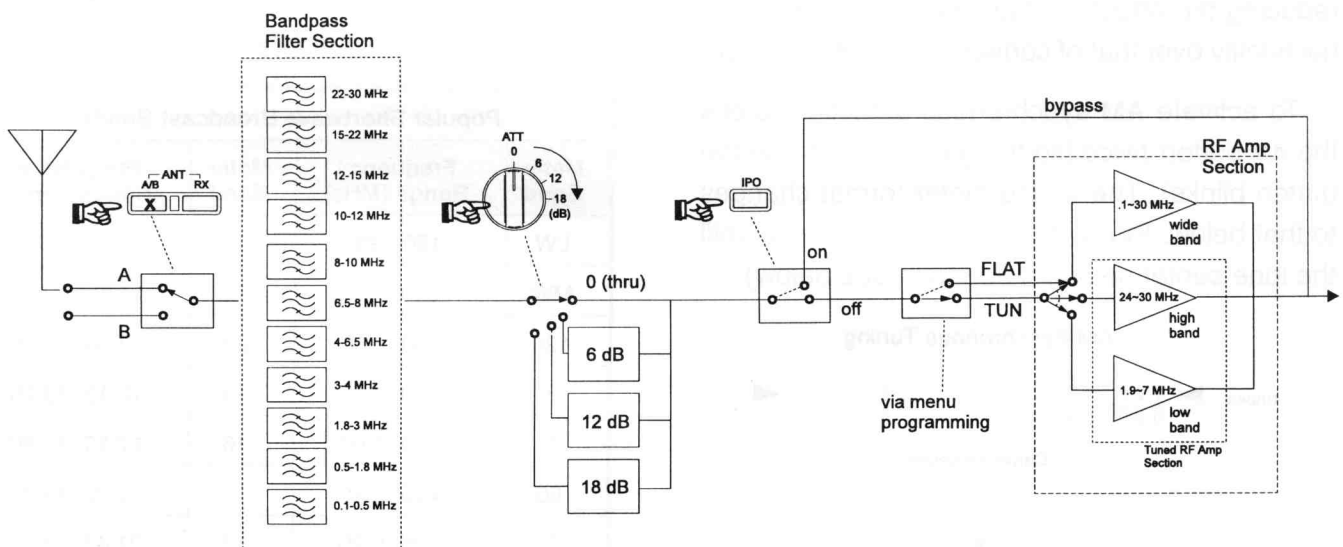

Receiver Front End Configuration  
(for illustrative purposes)



When looking for weak signals on a quiet band you will want maximum sensitivity, so the **IPO** should be disabled and **ATT** selector set to **0**. This situation is typical during quiet times on frequencies above 20 MHz, and when using a small antenna on other bands.

### AGC (Automatic Gain Control) Selection

When tuning around the band looking for signals, the **AGC** selector is usually best kept in the **AUTO** position, where AGC decay is automatically selected according to the operating mode. You can manually select receiver AGC; however, a few points about AGC and receiver recovery time need to be pointed out.

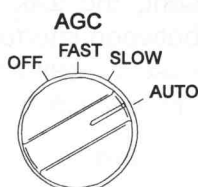

For SSB reception, the **FAST** position allows the receiver gain to recover quickly after tuning past strong signals or when fast fading occurs. However, once you have a station tuned in, reception will usually be more comfortable if you switch to the **SLOW** position (keeping the receiver from picking up low-level noise during pauses in speech).

For CW reception, when several signals are present in the passband, the **FAST** position can avoid AGC “pumping” (gain fluctuations) caused by strong undesired signals. For AM reception, the **SLOW** position is usually better, and for 300-baud packet and RTTY/AMTOR, the **FAST** or **OFF** positions will usually give the fewest errors/retries.

### RF Gain Setting

When tuned to a moderate strength signal, if low level background noise is still present after setting the **ATT** selector, try reducing the **RF GAIN** control from the fully clockwise position. This reduces the signal input to the first mixer via a PIN diode attenuator and causes the minimum S-meter reading to move up the scale, often clearing up the background noise and putting the desired signal more “in the clear.” Remember, however, to return this control fully clockwise when you want to receive weak signals, or read low levels on the S-meter. Also read the box on this page.



### Note on AGC

The **AGC OFF** position disables the overload-protection normally provided by the AGC circuitry. If the **RF** gain control is left fully clockwise in this condition, the RF and IF amplifiers can be easily overloaded (causing distortion) when a strong signal is received. Correct the overload either by setting the **AGC** selector to another position, or by turning the **RF** control counterclockwise to set receiver gain to a comfortable level.

### Noise Blanker Selection and Setting

The two noise blanker circuits in the FT-1000MP are provided for two different types of pulse noise. The **NB-1** button activates the narrow pulse blanker, for short pulse noise such as from switching transients, automobile ignitions and power lines. This blanker can sometimes also reduce the level of static crashes from electrical storms. The **NB-2** button activates the wide pulse blanker, for longer duration man-made pulse noise. If you hear any of these types of noise, just press either the **NB-1** or **NB-2** button so that the green LED above it lights, and turn the outer **NB** control clockwise.

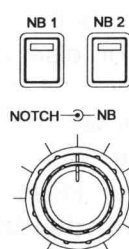

If the blanker seems to distort a signal you’re listening to, reduce the setting for optimum readability, or turn it off.

### IF Filter (Bandwidth) Selection

There are two banks of selectable filters, one each for both the 8.215 MHz 2nd IF and 455 kHz 3rd IF in the Main Receiver. Filter selections can be cascaded for versatility in combatting QRM and tailoring received audio. From the factory, 500 Hz and 2.4 kHz filters are provided for the 2nd and 3rd IF. Other filters can be ordered from your Yaesu dealer. Installation instructions are covered on page 100 and filter menu selections (5-0 through 5-7) on page 89. The illustration at the bottom of the page provides a representation of filter selection in the FT-1000MP.

Filters can be selected in pairs using the vertical buttons at the right, or else individually by first pressing 8.215 or 455, then selecting the filter from that bank as desired. Inside the bandwidth sub-panel, two columns of green indicators show the selected filter pair or combination. Try the following example:

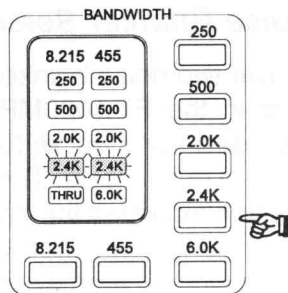

- Ex. Select the 2.0K 2nd IF and 250 Hz 3rd IF filter.*
- First press 8.215 (the left 8.215 column blinks) then 2.0K. The green indicator shows 2.0K selected in the left column.
  - Next, press 455 so the right column now blinks, then again press 250. The green indicator show 250 selected in the right column.

In AM mode, the 6-kHz AM wide bandwidth is selected for both the 2nd & 3rd IF (labeled **THRU** on the bottom of the 2nd IF column). This gives the highest fidelity, and is best on strong AM signals (and particularly music). The effects of the **SHIFT** and **WIDTH** controls in this wide bandwidth are subtle, but they can be helpful in fine tuning the audio characteristics. For weaker AM signals, or where adjacent channel interference is present, the **2.4K** bandwidth offers a compromise between interference rejection and fidelity. In this case the **SHIFT** and **WIDTH** controls can be used to improve fidelity (see the illustrations).

However, even better reception of AM signals under these conditions can usually be had by switching to an SSB mode (whichever gives the clearest reception), and superb reception of weak signals is often possible using diversity reception, described on page 46. In SSB modes, the 2.0K bandwidth button can sharply cut interference from unwanted signals on either side of the desired signal (although with some necessary loss of fidelity). In CW, the 2.0K or 2.4K bandwidth is often convenient to give "a wide view" of the band when tuning around, but once a signal of interest has been found and centered in the passband, the 500 or 250 (Hz) selections are much better.

In addition to selecting various filter combinations, you have several features that can be used singly, or in combination to eliminate or reduce the interference to an acceptable level. Although their use requires little more than rotating a control, it is good to have knowledge on how each function works and the effect on the QRM encountered.

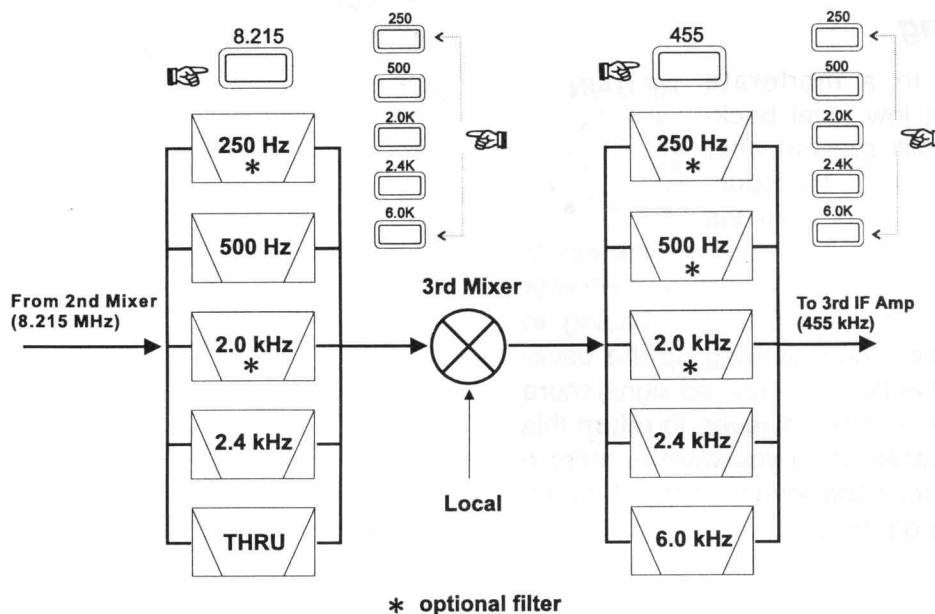

Main Receiver (VFO-A) IF Bandwidth Filter Selections

## WIDTH control

We just saw that specific IF filters can be selected to limit the receive bandpass to a pre-set width (essentially the total width of the installed filter). In a QRM condition, you ideally want to narrow the bandwidth just to the point where the unwanted signal is attenuated while still retaining enough bandpass to recover the desired station. In real-life band conditions, however, this ideal bandwidth is often somewhere "in-between" the several selectable filter bandwidths.

The **WIDTH** control can be used in all modes except FM to *continuously* narrow or broaden the bandpass skirt (within the limit of the selected filter) for the best skirt shaping and optimum cutoff and interference rejection during each QRM situation. Unlike older types of width controls that adjust both sides of the filter slope at the same time, the FT-1000MP's **WIDTH** control narrows the passband from either the upper or lower side (see illustration below). Thus, you only narrow the side of the bandpass where the QRM is located (why cut off more bandwidth than necessary?).

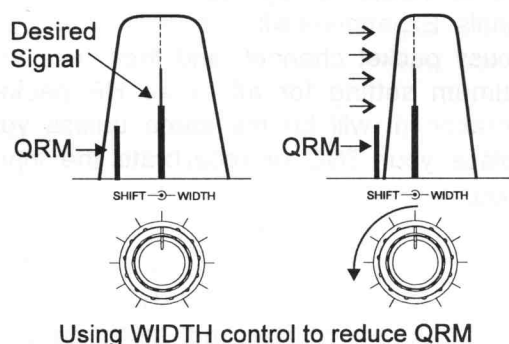
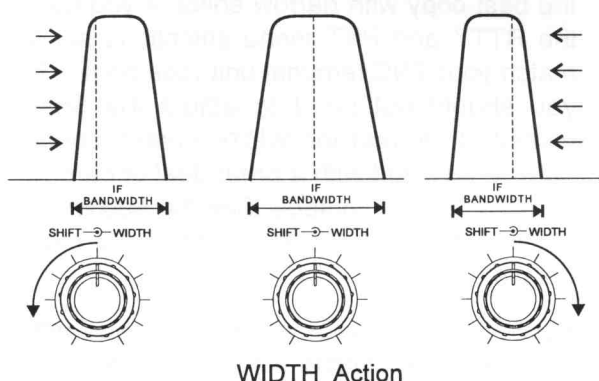

The center detent on the outer **WIDTH** control provides maximum bandwidth, which is equal to the selectivity of the filter used with the operating mode. Clockwise rotation moves the upper skirt of the IF passband lower in frequency, and counter-clockwise rotation moves the lower skirt upwards.

If a QRM condition occurs after tuning in a station, slowly rotate the control in the direction where the interference is reduced while the station is still workable. As you rotate the control you will hear the audio response change as the passband is narrowed. If the QRM is very close, the amount of bandwidth reduction necessary to cut the QRM may leave the desired station's audio unrecoverable, or it may not be possible to entirely eliminate the QRM.

When the QRM is all above or all below the desired signal it is usually only necessary to rotate the outer **WIDTH** control either to the left or right to cut the interference from the receiver passband. The **SHIFT** control (covered next) will also work for this, but may introduce interference from *the other side* of the signal.

## SHIFT control

The inner **SHIFT** control tunes the relative position of the receiver IF passband with respect to the displayed frequency in all modes except FM. The control is detented in the center position, which represents the passband center frequency, which is also the displayed frequency. Turning the control clockwise raises the passband center frequency, while turning the knob counter-clockwise lowers it.

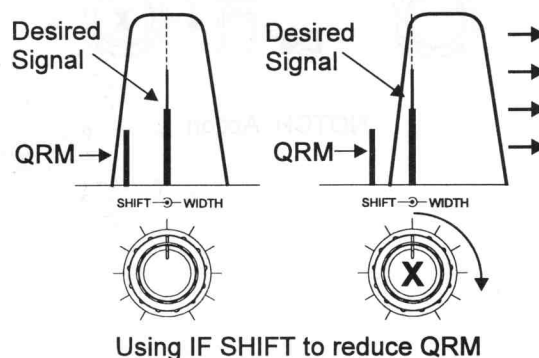
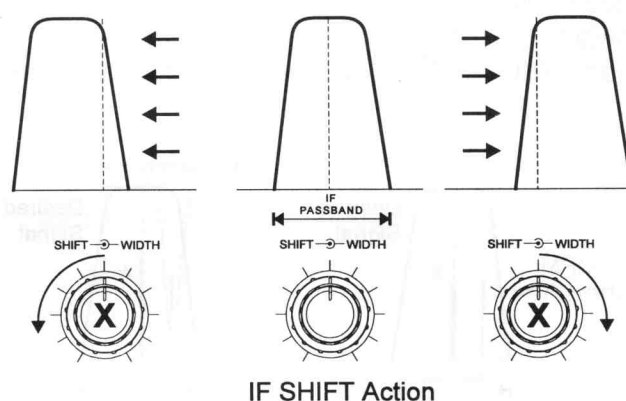

## Operation

When QRM is present on both sides of the tuned station, first adjust the **SHIFT** control just to the point where the interference from one side is eliminated, and then rotate the **WIDTH** control in the opposite direction to eliminate interference from the other side. The optimum settings of these controls depend on the relative signal strengths of the desired station and the QRM, and requires practice.

### SHIFT/WIDTH Tuning Steps

Rotating the **SHIFT** or **WIDTH** control tunes the IF passband using default 10-Hz steps. If desired, you can change to 20-Hz steps, which offers a faster response when turning the control knob. See menu selection 1-2 to set the default steps as desired.

### Notch Filter

After tuning in a desired signal and adjusting the IF bandwidth and shift, if heterodyne interference such as from a carrier or CW signal occurs, activate the IF notch filter by pressing the **NOTCH** button and *slowly* adjusting the inner control with the same name to null the heterodyne. Note that if the interfering carrier is more than about  $\pm 1.2$  kHz away from the center of the passband, the notch filter may be unable to null it. In this case, switch the notch filter off, and readjust the IF bandwidth and shift so that the undesired carrier is outside of the passband.

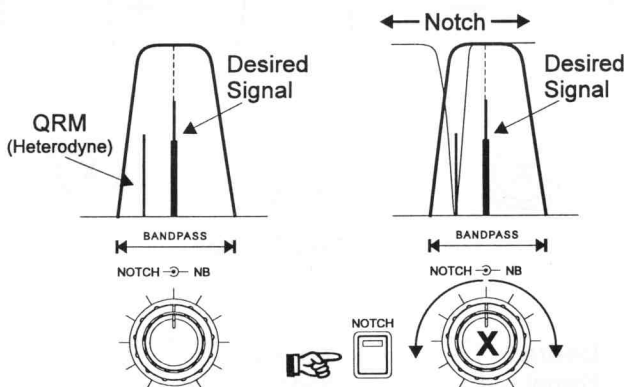

NOTCH Action

### Advice on QRM Reduction

Use the **BANDWIDTH** buttons and then the **SHIFT** and **WIDTH** controls to suppress the interference. Their use varies somewhat from mode to mode. In general, however, you will want to press the **LOCK** button beneath the tuning knob before adjusting the **SHIFT** and **WIDTH** controls, as accidentally retuning would invalidate your settings (particularly in narrow-bandwidth modes).

When you are ready to retune to a new frequency, press **LOCK** again to release it, and return the **SHIFT** and **WIDTH** controls to their default positions (center detent). The **WIDTH** control can also be turned counter-clockwise to reduce the IF bandwidth more gradually, and then the **SHIFT** control can be turned left or right from center to shift the center frequency lower or higher, as depicted in the drawing.

For digital modes, the wider bandwidth selections are fine for tuning around, but the **500** or **250** (Hz) bandwidths will generally give the best copy with narrow shifts. If you have the RTTY and PKT menu selections set to match your TNC/terminal unit (see page 55), you should not need to adjust the **SHIFT** control at all, and the **WIDTH** control should only be adjusted with a great deal of care (to avoid losing the contact). See the section on digital modes later in this manual for more details.

For 300-baud packet, use **500** (Hz) bandwidth and keep the **WIDTH** control centered; the **SHIFT** control may require fine tuning either side of center for optimum copy of weak signals. Experiment with the **SHIFT** setting on a busy packet channel, and then note the optimum setting for all future HF packet operation (it will be the same unless you replace your TNC or recalibrate the input tones).

**Note** - except during extreme QRM conditions, the **WIDTH** and **SHIFT** controls should be left in their center (detent) positions when tuning the receiver to a new frequency. This will provide the best fidelity and easiest tuning.

## Transmitting

The transmitter can be activated within the 500-kHz segment of any of the HF amateur bands, and from 28 to 30 MHz. When tuned to any other frequency, **GEN** is displayed at the left side of the display, and the transmitter is disabled. However, you are responsible to restrict your transmissions to those frequencies on which you are authorized to do so. You should also restrict transmissions to the frequencies for which your antenna is designed.

Band	TX Range
160 Meters	1.500.00 ~ 1.999.99 MHz
80 Meters	3.500.00 ~ 3.999.99 MHz
40 Meters	7.000.00 ~ 7.499.99 MHz
30 Meters	10.000.00 ~ 10.499.99 MHz
20 Meters	14.000.00 ~ 14.499.99 MHz
17 Meters	18.000.00 ~ 18.499.99 MHz
15 Meters	21.000.00 ~ 21.499.99 MHz
12 Meters	24.500.00 ~ 24.999.99 MHz
10 Meters	28.000.00 ~ 29.999.99 MHz

Attempting to transmit outside of an amateur band segment will cause the red **TRANSMIT** indicator to the right of the meter to blink. The transmitter is also temporarily inhibited when stopping memory scanning (described later), as pressing the PTT switch while scanning just causes the scanner to stop.

Whenever the transmitter is activated, the FT-1000MP automatically detects any reflected power that might appear at the main antenna jack (as a result of an impedance mismatch), and disables the transmitter if too much reflected power is found (in which case the red **HISWR** indicator at the right side of the display will be lit). Although this protection system should prevent any damage to the transceiver, we still recommend that you never activate the transmitter without having a proper antenna connected to the main **ANT** jack.

## Selecting Antennas

You can select between two rear-panel antenna connectors for transceive operation via the front panel, perhaps eliminating the need to purchase an external coaxial switch.

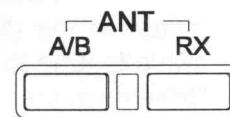

Press **A/B** to select the desired rear-panel jack you wish to use. The antenna connected to this jack is used for receive (and always for transmit). If a separate receive antenna is connected and **RX** is pressed, the antenna connected to the **RX ANT** jack will be used by the receiver. A relay engages during transmit and the last-selected antenna (A or B) will be used for transmit. Refer to the diagram below.

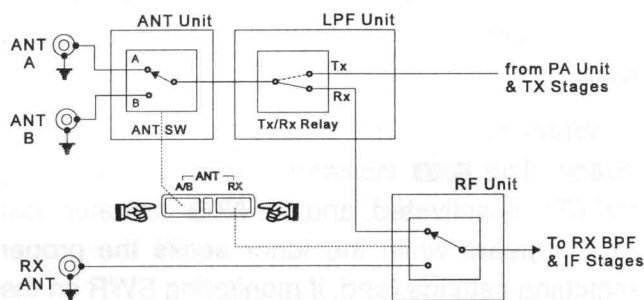

FT-1000MP Antenna Selection

Antenna selections are automatically copied along with other operating parameters during memory programming (covered later), and will take effect when memories are recalled later. However, if you do not want this data stored, you can select regular operation, or else disable **ANT** switch operation. When disabled, antenna selection remains fixed on jack **A**. Recall menu selection 8-5 to configure the **ANT** switch function as desired.

## Automatic Antenna Matching

The built-in automatic antenna tuner unit is capable of matching antenna with impedances from 20~150Ω, which corresponds to a maximum SWR of approximately 3.0:1. If the antenna you are using exceeds this SWR as configured, it must be adjusted (mechanically or electrically) until a feedpoint impedance closer to 50Ω can be obtained.

After using it once on your favorite bands, it recalls previous settings from memory (the tuner

**CAUTION!**

If **HISWR** is displayed at any time, the tuner is unable to match your antenna to the transmitter at the displayed frequency. You will have to tune to another frequency, or repair or replace your antenna or feedline.

has 39 of its own) during reception, whenever you tune to the same part of the band again.

When you use the tuner the first time on an antenna, set the **RF PWR** control to around the 9 o'clock position, to minimize interference you might cause others, and also to minimize stress on the tuner, feedline, and antenna (in case there is a high SWR). Ensure beforehand that the frequency you will transmit on is clear of other signals. Also, if you want to monitor the tuner's action visually, set the meter **IC/SWR** selector to display **SWR**.

When the channel is clear, press the **TUNER** button. The **TUNER** indicator comes on, indicating the ATU is activated, and the **WAIT** indicator next to it appears while the tuner seeks the proper matching settings (and, if monitoring SWR on the meter, you should see the tuner select the lowest possible reading). When the **WAIT** indicator turns off, you are ready to transmit (assuming the **HISWR** indicator didn't light).

After using the antenna tuner, the **TUNER** indicator will remain on (unless you press the **TUNER** button to turn it off), and the **WAIT** indicator will appear occasionally when you change frequency, indicating that the main microprocessor is reporting the frequency change to the tuner coprocessor (reception is unaffected). If you have tuned far enough to possibly require rematching, it will reset itself to the new range (if it has any previously stored settings for the new range). However, when you first connect a new antenna, the tuner will not have the correct settings stored in these memories, so you will need to "train" the tuner, by pressing the **TUNE** button whenever you change to a new band or frequency range (for this antenna).

If you want to use an external ATU or manual-type tuner, the internal ATU can be disabled via menu selection 8-8.

**SSB Transmission**

To transmit in LSB or USB mode:

- Make sure the appropriate mode indicator is lit, and set the meter **ALC/COMP** selector to view **ALC**.
- If this is the first time you are transmitting SSB with the FT-1000MP, preset the **MIC** and **RF PWR** controls to about the 12 o'clock position, and make sure the **VOX** is off (button out).
- Check the **RX** and **TX** LEDs above the tuning knobs to determine which frequency you're going to transmit on, and make sure **GEN** is not showing to the left of the main frequency display.
- To transmit, just press the PTT (push-to-talk) switch on your microphone, and talk.

To determine the optimum setting of the **MIC** control for your microphone, adjust it while speaking into the microphone (at a normal level) so that the meter deflects to about midrange on voice peaks (the upper end of the red ALC range). Once found, this setting can be left as it is unless you change microphones.

You can adjust the **RF PWR** control for more or less output, from about 5 to 100 watts (on the upper **PO** meter scale), as desired. However, you should always use the lowest possible power output to maintain reliable communications — not only as a courtesy to other stations, but to minimize the possibility of causing RFI and TVI, and to reduce heat generation and maximize the life of the equipment.

**Transmitter Monitor**

The transmitter monitor is actually a separate receiver circuit which picks up a sample of your transmitted RF signal, allowing you to hear accurately how the signal sounds. This feature is very helpful for setting up the speech processor controls, among other things.

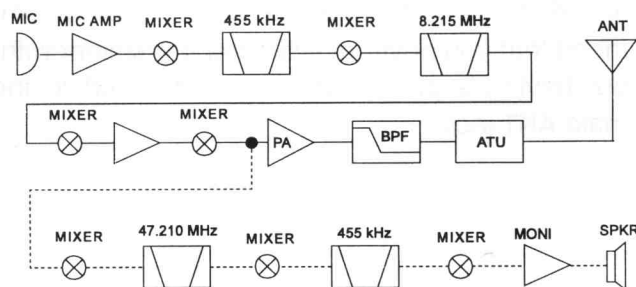
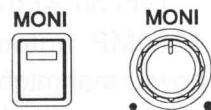

**Monitor Circuit**

Activate the monitor by pressing the orange **MONI** button (below the **AF GAIN** control) so that its green LED lights, and adjust the **LEVEL** control beneath the meter for comfortable volume while transmitting. Audio feedback of your signal from the loudspeaker to the microphone may occur if the **LEVEL** control is not properly set, you may want to use the monitor with headphones; if so you should plug them in now if you have them.

### Microphone Tone Selection

Before setting up the speech processor, set the selector switch on the rear of the MH-31B8 microphone (supplied) for the desired tone characteristic. The higher numbered setting suppresses low frequencies.

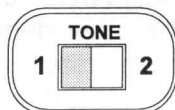

### RF Speech Processor

Once the proper **MIC** control setting has been determined, you can activate the RF speech processor to increase the average power of your transmitted signal.

- First set the **METER** selector to the **ALC** (Automatic Level Control) position, and ensure the level is within the red zone while speaking into the microphone.
- Next set the **METER** selector to the **COMP** (speech processor compression) position, and press the **PROC** button (at the left end of the row of buttons along the bottom) so that its orange LED lights.
- Now while speaking into the microphone, adjust the **PROC** control for a compression level of 5 to 10 dB on the **COMP** scale of the meter (the second scale from the bottom). If you have the monitor activated, you will be able to hear the effect of the compression on your signal. In any case, we do not recommend higher compression settings, as your signal will become less readable.
- Finally, move the **METER** selector back to the **ALC** position, and (without touching the **MIC** control setting) adjust the **RF PWR** control so that the meter reads in the upper end of the red **ALC** scale on voice peaks.

**Remember** -With the speech processor on, the **RF PWR** control now functions as a drive level control for ALC adjustment, and is no longer used for carrier output power adjustments.

### VOX (Voice-Actuated T/R Switching)

VOX operation allows you to activate the transmitter in any voice mode merely by speaking into the microphone, without having to press the PTT switch.

For the VOX circuit to operate properly, three controls in the top access panel must be set to match your microphone and the acoustic environment of your station. Once set, these controls should not require readjustment unless you change your microphone or station location.

(located on the ALC Unit beneath the top cover access panel)

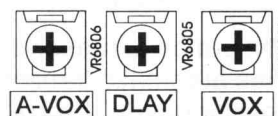

Controls for VOX Operation

- First make sure the receiver is set for normal volume on a clear channel, and preset the **VOX** (gain) control in the top access panel fully counterclockwise. Also preset the **A-VOX** (anti-vox) and **DLAY** (vox delay) controls in the top access panel to their 12 o'clock positions.
- Set the **RF PWR** control fully CCW (to avoid creating interference while you set up the VOX controls). Now press the **VOX** switch near the upper left corner of the front panel.
- Without pressing the PTT switch, speak continuously into the microphone while slowly advancing the **VOX** control (in the top access panel) clockwise, just until your voice activates the transmitter.
- Now speak intermittently into the microphone, and note the "hang time" between the moment you stop speaking and when the receiver is reactivated. This period should be just long enough so that the transmitter remains keyed between words, but drops back to receive during pauses. Adjust the **DLAY** control, if necessary, for comfortable hang time.

The **A-VOX** control probably needs no adjustment, but if you find that, with the microphone in its normal operating position, receiver audio from the loudspeaker trips the transmitter, advance the **A-VOX** control more clockwise. On the other hand, if transmitter keying with the VOX keying seems sluggish or unstable when you speak into the microphone, try a more counter-clockwise setting.

## CW Transmission

There are several types of CW transmission available with the FT-1000MP. All require, of course, that you have a CW key or keyer paddles connected to either of the **KEY** jacks on the front or rear panel (with a 3-contact plug). You simply use the **RF PWR** control to set your output power.

### Straight-Key Operation

- First preset the **RF PWR** control to about 12 o'clock. Of course you must select the CW mode, if you haven't already, and for now, make sure the **KEYER** and **BK-IN** switches near the lower right corner of the front panel are both off.
- Press the **VOX** button to turn on the VOX circuit, which provides automatic transmitter activation when you close your key. If you want to practice CW with the sidetone, you can leave the VOX off.
- To transmit, simply close your key and advance the **RF PWR** control for the desired power output level.
- You can adjust the CW sidetone volume, if necessary, for a comfortable level using the trimmer accessible via the hole on the rear panel (see item #3 on page 19).
- Release the key to return to receive.

You are now using semi break-in CW, in which the transmitter remains activated except during pauses in your sending. You can set the delay during which the transmitter remains on after you stop sending, by adjusting the keyer delay setting (menu selection 7-5).

However, if you prefer full break-in (QSK) operation, in which the receiver is activated between each dot and dash, simply press the **BK-IN** switch.

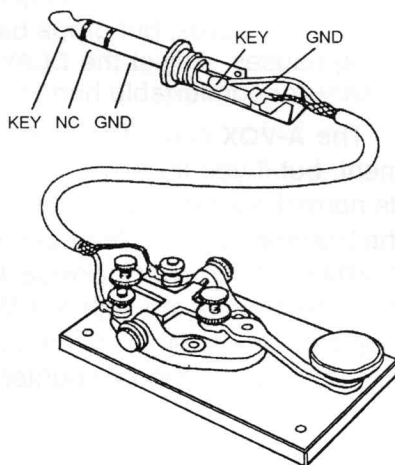

## Electronic Keyer Operation

The built-in electronic keyer offers two iambic modes and a mechanical "bug" keyer emulation. You will need to connect keyer paddles to one of the **KEY** jacks to use the keyer.

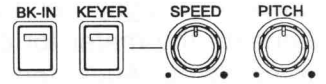

The keyer is set at the factory for iambic keying, in which one keyer paddle produces dits, and the other dahs. Squeezing both produces alternating dits and dahs. Menu selection 7-0 allows choosing three keyer modes:

**Iambic 1** - Iambic keyer with ACS (Auto-Character Spacing) disabled. Weighting is user-selectable via menu selections 7-1 & 7-2.

**Iambic 2** - Iambic keyer with ACS enabled. Weighting is set via menu selections 7-1 & 7-2.

**BUG** - Emulates mechanical "bug" keyer (one paddle produces dits and the other is used to produce dahs manually (like a straight key),

- Once the transceiver has been set up for CW transmission as just described, you can activate the keyer with the **KEYER** pushbutton near the lower right corner of the front panel (its green LED should light).
- Now squeeze the paddles, and adjust the **SPEED** control for the desired speed (if you are using the bug simulator mode, don't squeeze both paddles; just press the dit paddle).

If the dot:dash weighting is not to your preference, see menu selections 7-1 & 7-2 to configure keyer settings. You can use the keyer for both semi and full break-in keying, as described in the previous section.

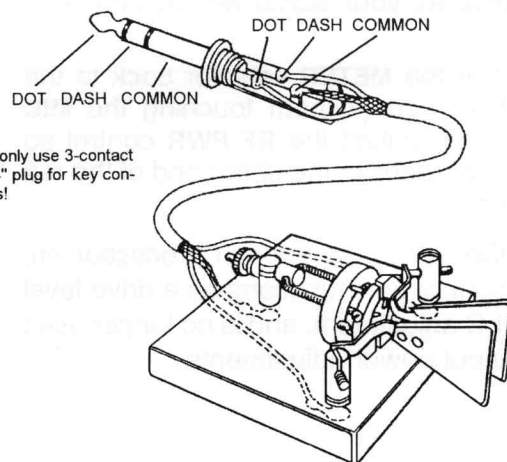

\*Note - only use 3-contact type 1/4" plug for key connections!

## CW Straight Key and Paddle Connections



### ACS (Auto Character Spacing)

This feature improves your CW sending quality by ensuring the inter-character spacing of dits and dahs remains constant. Although dot/dash weighting is automatically maintained at the desired ratio, the inter-character spacing can sometimes vary from operator to operator, and proportional spacing is sometimes not maintained. This does not present much of a problem during slow CW sending, but at higher speeds, the effect is more pronounced and sometimes makes copy difficult.

ACS works on the principle that the spacing between characters should be 3x the duration of the "dot." If you happen to have a 3:1 dash:dot ratio, this also happens to be the same duration of a "dash." Maintaining this inter-character spacing is what prevents the sent characters "E" and "T", for example, from merging into what sounds like the character "A" (see illustration).

ACS is activated when keyer mode EL2 is selected from menu function 7-0. Paddle inputs are automatically adjusted by ACS before transmitter keying.

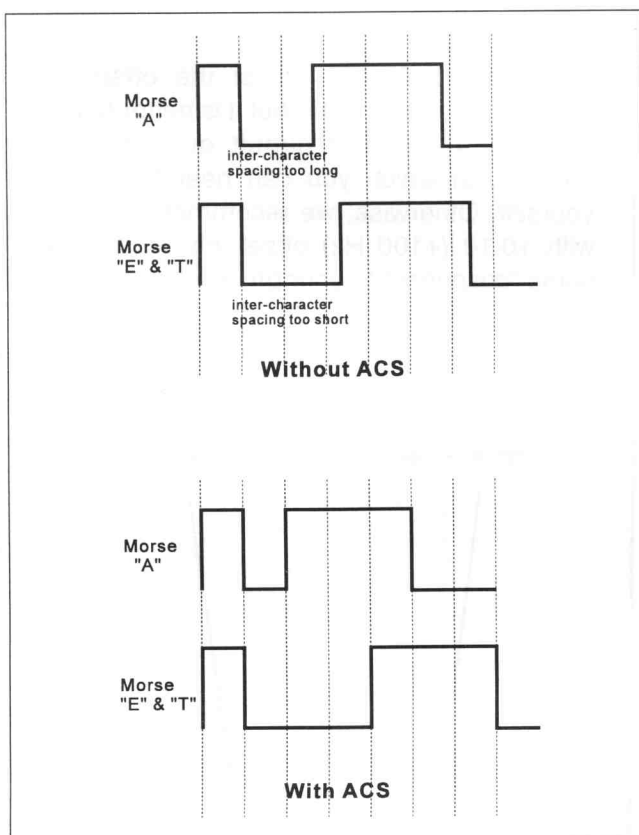

### Keyer Settings

**Keyer Dot & Dash Weighting** - The default keyer has a dash:dot ratio of 3:1. However, you can select EL2 and separately configure the dot and dash duration for the weighting you desire. Menu functions 7-1 and 7-2 adjust these default settings.

**Keyer Delay** - For QSK (break-in) CW operation, the switchover time delay from Tx to Rx can be adjusted from 0 seconds (full break-in) to 5.10 seconds (in 10-msec) using menu selection 7-5.

**CW Break-In** - The switching time of the CW carrier waveform can be adjusted from 0 to 30 milliseconds for use with linear amplifiers with T/R switching circuits not designed for full-QSK operation. Menu selection 7-4 controls the time delay. See *Linear Amplifier Operation* on page 67 for more details.

**Contest #** - A 4-digit number can be programmed for CW contest work. See *Remote Control Operation* (page 60) and menu function 7-3.

### CW Pitch Setting and Spot Tone

In CW mode (only), pressing the **SPOT** switch on the lower edge of the front panel activates the CW sidetone, which is also used as a spotting oscillator. The frequency of this tone is also (exactly) the frequency that the IF center frequency and display are offset from the true carrier frequency during CW reception.

You can press this switch when tuning in another station for the same tone as your sidetone, so that when you transmit, your signal will be on exactly the same frequency as his. Also, you will know that his signal is centered in your IF pass-band which ensures that you will not lose track of his signal when switching to a narrower filter. Of course, you should turn off the **SPOT** switch to copy his signal.

The CW pitch can be set from 300 ~ 1050 Hz (in 50-Hz increments) to match that used by popular TNC (Terminal Node Controller) units and other CW decoders. If you know the CW pitch used with your unit, set this to match. While adjusting the pitch, you can have the frequency shown in the clarifier sub-display by enabling it via menu selection 3-5.

- To adjust the CW pitch (and spot tone along with it), press the **SPOT** switch then rotate the **PITCH** control to set the tone to the pitch you prefer, or that used by your TNC or CW de-

coder. If the sub display is enabled for CW pitch you can view the default pitch frequency as you adjust it. The spot tone volume can be adjusted using the **SIDETONE** potentiometer accessible on the rear panel of the transceiver).

In addition to the spotting oscillator, the directional tuning meter provides a constant visual indication of any signal at the center of the IF passband (if not too weak). You can just tune so that the segment flashes in sync with the signal of interest when it is centered (see page 28).

### AM Transmission

Transmitter setup for the AM mode is essentially the same as for LSB or USB, except that you must avoid overmodulating, and limit carrier power to 25 watts.

- VOX can be used in the AM mode, but for now, make sure the **VOX** switch is off, so as not to confuse adjustments.
- With the **AM** mode selected, press the **METER ALC/COMP** button to view the ALC range.
- Press the PTT and rotate the **RF PWR** control for the desired power output (remember to limit transmitter carrier power to 25 watts in the AM mode).
- If you have already set the **MIC** control as described for SSB transmission, there should be no need to readjust it. If not, close the PTT, and adjust this control just to the point where the ALC begins to deflect slightly, and stays within the red ALC zone. Don't set it too far beyond this point, or your signal will become distorted from over-modulation.
- The transmit monitor is very helpful in setting the correct modulation level, and if you have headphones on, you should turn the monitor on now.

Note that the speech processor is disabled in the AM mode. You can, however, activate the VOX if desired.

### FM Transmission

For transmission, the only control on the front panel you need be concerned about is **RF PWR**. Microphone gain for FM is set via the separate **FM MIC** control in the top access panel, and normally needs no adjustment after leaving the factory. If you receive signals reports of low audio with a strong carrier, you may want to increase the gain. If you notice distortion in the transmit monitor, you may want to decrease it. Otherwise, we suggest leaving it alone.

### Carrier Point Offset

This feature allows shifting the carrier point IF passband (and hence the RF passband as well) of your transmitted signal in the SSB mode, to customize your signal for your own voice characteristics.

Seven individual carrier settings can be user-adjusted:

**USB Carrier** (Tx & Rx) - adjustable from -200 ~ +500 Hz.

**LSB Carrier** (Tx & Rx) - adjustable from -200 ~ +500 Hz.

**Processor Carrier** (USB & LSB) - adjustable from -200 ~ +500 Hz.

**AM Carrier** - adjustable  $\pm 3000$  Hz.

To display and adjust the various carrier settings, see menu selection 8-9. With the offset displayed, you can adjust it throughout the ranges shown above. A minus sign indicates the offset is closer to the carrier (low-frequency speech emphasized). You can transmit during carrier display and adjustment.

Of course, you can adjust the offset by trial-and-error on the air, but it is better to use the built-in monitor circuit or a monitor receiver, in which you can hear the effect yourself. Otherwise, we recommend starting with +0.10 (+100 Hz) offset initially, to add some "crispness" to your processed speech.

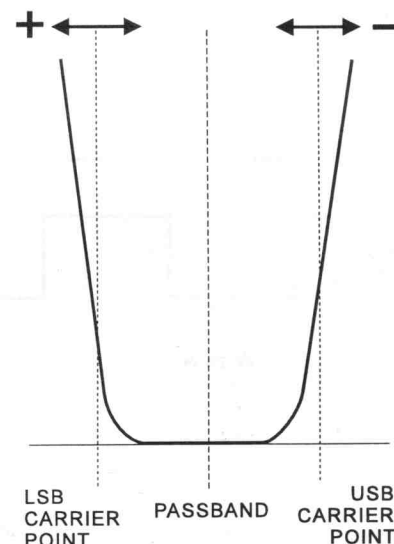

### FM Repeater Operation

Several features are available for operation on FM repeaters above 29 MHz which use 100-kHz splits.

To locate these repeaters, you can ask around the calling channel (29.6 MHz), or you may want to load a block of memory channels (see page 47) with 50-kHz frequency multiples from 29.61 to 29.7 MHz (and FM mode, of course). Then set the squelch so that the receiver is silent on a clear channel, and hold the microphone **UP/DWN** keys to scan the memories.

*Repeater Shift* - When you find a repeater, press the **RPT** button, once for “-” shift (to transmit 100 kHz below your receiving frequency). Pressing it again will select “+” shift, but this is not used above 29.6 MHz. Press it once more to return to simplex. Try a quick identification transmission to make sure you have the shift right.

*Repeater TX Offset* - For repeaters not using the standard 100 kHz offset, you can change the default offset between 0 ~ 200 kHz via menu selection 6-9.

*CTCSS Tone* - A low-level 88.5-Hz subaudible tone is transmitted to access closed repeaters. Should a different CTCSS tone be required, you can choose any one of 33 standard tones via menu selection 6-7.

*Tone Duration* - Continuous or burst CTCSS tone transmission is enabled from menu selection 6-8.

CTCSS Tone Frequencies		
67.0 Hz	118.8 Hz	173.8 Hz
71.9 Hz	123.0 Hz	179.9 Hz
77.0 Hz	127.3 Hz	186.2 Hz
82.5 Hz	131.8 Hz	192.8 Hz
88.5 Hz*	136.5 Hz	203.5 Hz
94.8 Hz	141.3 Hz	210.7 Hz
100.0 Hz	146.2 Hz	218.1 Hz
103.5 Hz	151.4 Hz	225.7 Hz
107.2 Hz	156.7 Hz	233.6 Hz
110.9 Hz	162.2 Hz	241.8 Hz
114.8 Hz	167.9 Hz	250.3 Hz

All you need to do is set the **METER** selector to the **PO** position, and adjust the **RF PWR** control for the desired output while transmitting. If you need full power, keep your transmissions to three minutes or less, with the same time for reception.

You can use the **VOX** circuit for t/r switching, if desired, and the transmit monitor to listen to your signal. See also the FM Repeater Operation box.

### Clarifier (Rx/Tx Offset Tuning)

The three **CLAR** buttons near the lower right corner of the front panel, and the control just above them, are used to offset either the receive, transmit, or both frequencies from their settings on the main display. The three small numbers in the center of the display (just to the right of the main frequency display) show the current clarifier offset (this can be changed, however, to display other settings - see the following page). The clarifier controls on the FT-1000MP are designed to allow you to preset an offset (up to  $\pm 9.99$  kHz) without actually retuning, and then to activate it with the clarifier's **RX** and **TX** buttons.

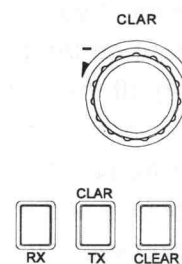

Perform the following steps, if you like, to familiarize yourself with the clarifier controls:

- Without pressing any of the clarifier buttons, rotate the **CLAR** knob back and forth while watching the small center display. Notice that the small digits change, indicating the *preset* clarifier offset (which hasn't been applied to the Tx or Rx frequency yet) while the main display remains unchanged.
- If you press the clarifier **TX** button, **CLAR-TX** appears below the smaller offset display, and if you press the PTT you will see the Tx frequency shift by the amount of clarifier offset.
- If you press **RX** instead, notice that **RX-CLAR** appears and the frequency offset is applied and the display shifts to the offset receive frequency accordingly. Press the PTT switch, and notice that the transmit frequency remains the same as the original frequency display when the receive clarifier is on. You can reset the offset to 0.00 kHz at any time by simply pressing **CLEAR**.
- With the **RX** clarifier active, the center tuning marker just above the main frequency display moves to the right or left as you change the offset by rotating the **CLAR** knob. Also notice that the main frequency and the clarifier offset displays change together.

- Now press the clarifier **CLEAR** key and observe that the offset is cleared to zero, and the Main VFO frequency returns to what it was originally.

The clarifier is commonly used when you are in contact with a station whose transmitter drifts (or perhaps you didn't have him quite tuned in when you called him). You don't want to change your transmitting frequency, as that would force him to retune — you just want to adjust your receiver.

When you finish your QSO, remember to press the clarifier **RX** button again to turn off the clarifier. However, if you hear another station you want to call right on the frequency he was on, instead of turning off the clarifier, you can just press the **TX** clarifier button to bring your transmitter onto the same frequency, and make your call (now both the receive and transmit frequencies are offset by the displayed amount). Keep in mind, however, that you will need to press both the **RX** and **TX** clarifier buttons again to turn off the clarifier when you finish. You might also want to clear the offset when done.

The FT-1000MP actually has an independent clarifier for each VFO, on every band and alternate sub receiver, plus one on each of the 99 memories. This means that clarifier TX/RX and offset settings are not carried over when you change bands or memory channels, but rather are stored until you return to that VFO, band, sub receiver, or memory again.

### Clarifier Settings

There are several settings that affect clarifier operation and the way the frequency is displayed that you should be familiar with. After understanding their relationships, you can set them as desired.

**Tuning Steps** - The default 10-Hz tuning steps for the clarifier can be changed similar to the VFO's using menu function 1-9. Choose between 0.625 Hz, 1.25 Hz, 2.5 Hz, 5 Hz, 10 Hz or 20 Hz clarifier steps.

**Clarifier M-Tune** - Programmed memories can be re-tuned using the clarifier when this is enabled (menu function 1-8). We will discuss memory tuning in detail later on.

### Offset Display Mode

The small sub-panel to the right of the MAIN VFO-A display can be configured to show one of four different operating parameters.

By default the Tx or Rx clarifier offset appears. However, this can be changed to the channel frequency, split offset (difference between VFO-A and VFO-B), or else the CW Pitch setting. Which display you choose, of course, depends on your operating habits, but can be easily changed using menu function 3-5. The following is a brief description of each display mode.

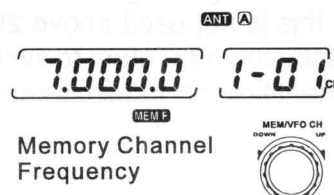

**Clarifier Offset** - this 3-digit display shows the clarifier Tx or RX offset ( $\pm 9.99$  kHz) to be applied to the operating frequency.

**Channel Frequency** - this displays the frequency stored in the memory channel displayed to the right. If the memory has not yet been stored with data, the display remains blank (except for a lone decimal point).

**Offset** - displays the absolute (+/ -) frequency difference between MAIN VFO-A and SUB VFO-B. For operators chasing DX stations working split, this makes tuning "down" easier (no mental subtraction from your operating frequency is needed).

**CW Pitch** - this displays the CW BFO pitch as adjusted by the **PITCH** control at the lower right corner of the front panel.

## Using Sub VFO B

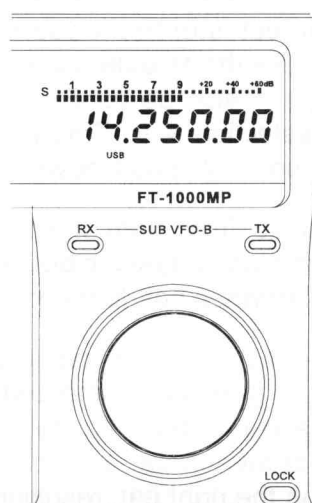

The Sub VFO works in a similar manner to the Main VFO, with which you should be familiar by now. The Sub VFO provides simple split (transmit/receive) frequency operation via the **[SPLIT]** button, and, more importantly, dual-channel reception via the **[DUAL]** button. We'll get into those in a minute, but first let's look at how to control the Sub VFO.

Frequency, mode, and clarifier data can be transferred from the Main VFO to the Sub VFO by pressing **[A-B]**, but don't forget that this will overwrite any settings that were in the Sub VFO previously. Also, the contents of the two VFOs can be swapped (with no loss of data) by pressing **[A-B]**.

Most selections for the Main VFO can also be made for the Sub VFO directly, by pressing **[SUB CE]** right before another keypad key to select a band, or before a mode button to change the Sub VFO mode (displayed below the Sub VFO frequency).

Unlike the Main VFO, with its triple-conversion receiver, the Sub VFO receiver uses *double-conversion* circuitry with 47 MHz and 455 kHz intermediate frequencies. A 6-kHz AM filter and 2.4-kHz SSB/CW filter come installed from the factory. For CW work, a third optional 500-Hz narrow filter is also available from your dealer. After installation, this filter pathway must be enabled via menu selection 5-8 (set it to "ON"). Filters are selected *automatically* in the sub receiver, but the defaults may be overridden by pushing **[SUB CE]** → [2.4K], for example, to switch to the 2.4-kHz filter in the CW mode.

When you press the **[SUB CE]** key, the entire display for the Sub VFO will blink, after which you have five seconds to press another key. Note that to switch VFO registers in the Sub VFO, you need

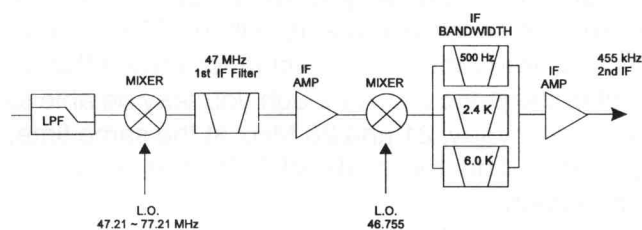

Sub Receiver IF Diagram

merely press the **[SUB CE]** key followed by the key for the same band that the Sub VFO is already on.

Additionally, you can enter a frequency from the keypad into the Sub VFO by pressing the **[SUB CE]** key before pressing the **[ENT]** key (and the digits of the new frequency you want to enter into the Sub VFO, followed by **[ENT]** again).

Of course, you can tune the Sub VFO using its tuning knob, and use faster tuning steps by holding the **FAST** button (below the left side of the main tuning knob). You can use the large **DOWN** and **UP** keys (in both normal and 1-MHz fast steps) for the Sub VFO as well, if you just press the **[SUB CE]** key first.

About the only things you cannot do with the Sub VFO (that you can with the Main VFO), are store it directly into a memory, and set the clarifier. For these functions you need to swap it with the Main VFO first (push **[A=B]**, then hold the **[A-M]** button for 1/2-second (to store it in a memory) or set the clarifier, and then press **[A=B]** again to return the data to the respective VFOs.

### Dual Reception

Pressing the blue **[DUAL]** button activates the SUB VFO-B receiver. The **[DUAL]** indicator appears at the left of the display, and the green **RX** LED above the SUB VFO-B tuning knob lights. Dual receive operation opens up exciting operating possibilities for split operation, contesting, and chasing elusive DX stations.

#### VFO Tracking

To have Sub VFO B track the Main Receiver VFO while tuning (with dual reception on or off), simply hold the **LOCK** button depressed.

With **LOCK** depressed, the **TRACK** indicator appears when the main tuning knob is rotated, and the Sub VFO tracks the Main receiver. Release the button to resume normal tuning.

## Operation

The Main and Sub VFO share the *same antenna and front-end bandpass filter*, and so should be tuned fairly close to each other for maximum sensitivity (that is, within 500 kHz or so at low frequencies, or within several MHz at higher frequencies). Although you may be able to receive on, say, 21 and 28 MHz at the same time, you may find the SUB VFO-B receiver signal attenuated.

There are 12 BPF networks in the receiver front-end circuitry, each covering a particular segment of the transceiver's full receive range. SUB VFO-B receiver specifications are only guaranteed while tuning within the same bandpass as the MAIN VFO-A.

### Main and Sub VFO Audio

The **AF GAIN** control has concentric controls for both MAIN and SUB VFO volume. The effect these controls have on receiver audio can be changed, and is configured using menu selection 4-9. AF GAIN control knob operation can be set to either of the two following modes:

**Separate** - the receiver volume for the MAIN and SUB VFOs is adjusted *independently*. This simply means that the center (MAIN) knob controls SUB VFO-A volume and the outer ring controls SUB VFO-B.

**Balance** - the center knob adjusts the volume for both the MAIN and SUB VFO *simultaneously*. The outer ring now functions as a "balance" control between main and sub audio.

**Note** - to "reverse" Main and Sub receiver audio at any time, press the **AF REV** button just to the left of the **UP/DWN** keys so its LED lights. The functions of the center and outer **AF GAIN** controls are now switched. Press the button again to return operation to normal.

Remember that when the SUB VFO B is turned off by pressing **DUAL** again, the **AF GAIN** control configurations no longer apply.

### Using Headphones for Dual Receive

To take advantage of dual reception, you will want to connect stereo headphones to the **PHONES** jack. Like the **AF GAIN** control, headphone audio mixing can also be configured as desired from menu selection 4-8. Three audio mixing schemes are selectable as follows:

**Mono** - audio from both the main and sub receiver is combined equally in both ears (as from the loudspeaker when headphones are not used).

**Stereo 1** - this is a combination of the above two modes and gives you some audio from each channel in each ear, but with the main receiver emphasized in the left ear, and the sub receiver emphasized in the right ear, resulting in a kind of "3-D" spatial audio effect.

**Stereo 2** - audio from the main receiver is only heard in the left ear, and audio from the sub receiver is heard only in the right ear.

Note that both the MAIN and SUB VFOs must be activated by pressing **DUAL** and the **AF GAIN** control must be balanced (centered) to hear both receivers. Compare these two positions with both VFOs tuned to signals, to select the audio mixing scheme you prefer.

Also observe that the **RF GAIN**, **SHIFT**, **WIDTH**, **NOTCH**, and **AGC** functions do not affect the sub receiver (AGC is automatically selected according to mode, or else from menu selection 8-7).

### Headphone Audio Adjustments

The Main and Sub receiver audio levels available from headphone jacks A & B are manually adjustable. Underneath the top panel access cover are four trimpots allowing individual adjustment of Main and Sub audio for each headphone jack. With a headphone inserted into the appropriate jack, you can rotate these controls using a small insulated screwdriver for optimum level and balance. Refer to the drawing below for trimpot locations.

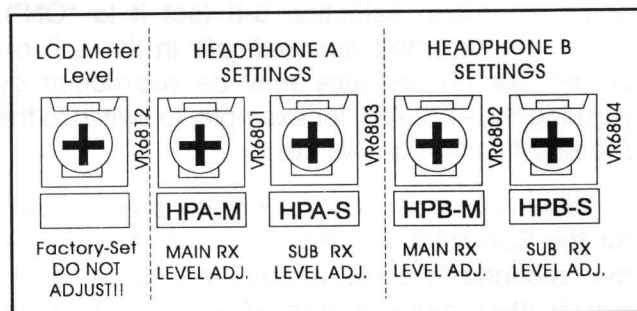

## Split Frequency Operation

Typical split operation involves receiving on the Main VFO (A) or a memory channel, and transmitting on the Sub VFO (B). The special case of FM repeater operation uses some features of its own, and is described in the box on page 41.

Rare DX stations often announce that they will "listen up" or "listen down" a few kHz (from their Tx frequency) when calling CQ or during contests to avoid being covered by the DX pileup from responding stations that often occurs.

To activate Split operation, you can either press **[SPLIT]** or the **TX** button/LED above the Sub VFO-B tuning knob. In either case **[SPLIT]** appears at the left of the display, and the red **TX** LED above the Sub VFO tuning knob lights. Split operation can be activated with or without dual reception, however, we recommend that you have dual receive on, to allow you to monitor your transmit frequency on the Sub VFO (while receiving), as well as the Main VFO receiving frequency, so you don't accidentally "step on" somebody.

A few button functions you will need to know for split operation are explained below.

**[SPLIT]** - pressing this activates the Sub VFO for transmission.

**[A=B]** - pressing this copies the displayed contents of Main VFO A into Sub VFO B, overwriting its previous contents.

**[A=B]** - pressing this switches "trades" the displayed contents of the Main and Sub VFOs.

## Split Operation Modes

The FT-1000MP offers three modes of Split operation (chosen by menu selection 8-2):

**Normal** - in this default configuration, pressing **[SPLIT]** activates Sub VFO-B for transmission. Other settings (such as mode and frequency) *must be manually set* for the Sub VFO.

**Auto** - when **[SPLIT]** is pressed, Sub VFO-B is enabled for transmit, and the selected operating mode from Main VFO A is *automatically copied* into Sub VFO-B. The transmission frequency must still be manually set for the Sub VFO.

**A-B** - same as Auto mode above, however, a preset frequency offset (known as a "Quick Split") is also applied to Sub VFO B for transmission.

The "Quick Split" is handy when you know the offset a DX station will be listening on beforehand. The offset is applied instantly, saving time and mental arithmetic. A Quick Split offset up to  $\pm 100$  kHz can be selected in menu selection 1-6.

The drawing below shows the effects on Sub VFO B for each Split operating mode. Also recall on page 42 that the sub panel offset display can be configured for split operation (that is, to display the current offset between the two VFOs).

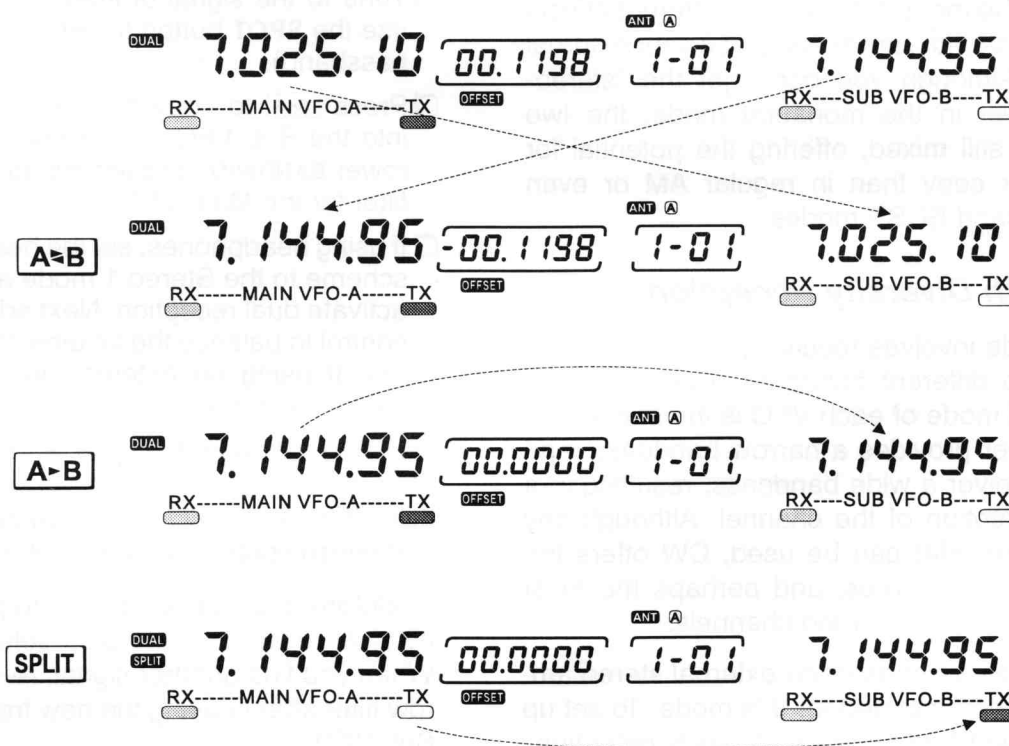

## Sideband Diversity Reception

Here you receive a single AM signal through the two receivers, each receiving the opposite sideband. Skywave-propagated signals often show phase distortion in this mode, but it gives you a view of the entire passband, from which you can then select the best sideband for listening (or for SWL Dx'ing, you may want to listen to both sidebands at the same time, to get the best copy). On groundwave signals, where the phase of the sidebands is likely to be the same, there is an interesting sense of depth to the signal.

To tune in a signal using this mode, you should have stereo headphones connected to the front panel **PHONES** jack, or an external stereo amplifier connected to the rear panel **AF OUT** jack.

- Set the Main VFO to either LSB or USB mode, and tune for zero beat on the desired signal.
- Press **[A-B]** to copy this mode and frequency into the Sub VFO, then press the mode button to select the opposite sideband for the Main VFO.
- If using headphones, set the headphone mixing scheme to the Stereo 1 mode and press **[DUAL]** to activate dual reception. Adjust the **AF GAIN** control to balance the volume of the two receivers. If using an external amplifier, adjust its balance control.

If interference is present on one of the channels, you may have to turn its **AF GAIN** control to suppress that channel. Otherwise, try changing the headphone audio mixing scheme to Stereo 2 or Mono in the menu selection for different effects (or try settings with similar effects on your external amplifier). Although you don't get the "stereophonic" effect in the monaural mode, the two signals are still mixed, offering the potential for much better copy than in regular AM or even single-sideband ECSS modes.

## Bandwidth Diversity Reception

This mode involves receiving the same signal through two different bandpass filters. The frequency and mode of each VFO is the same. The main receiver provides a narrow bandpass, and the sub receiver a wide bandpass, resulting in a spatial perception of the channel. Although any mode (except FM) can be used, CW offers the widest array of choices, and perhaps the most startling effects on crowded channels.

Stereo headphones or an external stereo amplifier are recommended for this mode. To set up the transceiver for bandwidth diversity reception:

### SUB VFO-B Settings

*S-Meter* - you can enable or disable the S-meter for the sub receiver via menu selection 3-6.

*Peak-Hold* - Additionally, if you want the "peak-hold" meter function (see page 28) for the Sub Receiver S-meter, it can be turned on/off by menu selection 3-8.

*Tuning Steps* - SUB VFO-B, step size (0.625 ~ 20 Hz) is selected in menu function 1-4.

*Sub Receiver AGC* - AGC attack can be switched from automatic (default) to either fast or slow using menu selection 8-7.

*Filters* - When installed, the optional 500-Hz IF filter can be selected from the front-panel via menu selection 5-8.

Lastly, if you want to disable SUB VFO-B operation entirely, it can be turned off from menu selection 7-8 (the display still appears and the SUB VFO-B knob can be turned, but nothing is received). While disabled, the sub receiver can be activated momentarily for split operation by pressing either **[DUAL]**, or the SUB VFO-B **RX** button/LED.

- Select the desired mode on the Main VFO, and the 2.0- or 2.4-kHz filter (or wide AM - press the **2.4K** button if it's LED is lit, so that it turns off).
- Tune to the signal of interest (if in CW mode, use the **SPOT** button to center the signal in the passband).
- Press **[A-B]** to copy this mode and frequency into the Sub VFO, then press one of the narrower **BANDWIDTH** selections to select a narrow filter for the Main VFO.
- If using headphones, set the headphone mixing scheme to the Stereo 1 mode and press **[DUAL]** to activate dual reception. Next adjust the **AF GAIN** control to balance the volume of the two receivers. If using an external amplifier, adjust its balance control.

Select the wider filter first, and copy that selection into the Sub VFO to allow extra flexibility using the Main VFO. For example, try the **SHIFT** and **WIDTH** controls for some interesting effects.

Before retuning, remember to press **[DUAL]** to turn off dual reception, and also select a wide filter. When you find another signal, re-select your narrow filter after copying the new frequency into the Sub VFO.



## Memory Features

### Memory Structure

The FT-1000MP contains ninety-nine regular memories, labeled 1-1 through 1-99, nine special programmed limit memories, labeled P1 through P9, and five QMB (Quick Memory Bank) memories, labeled C1~C5. Each stores the Main VFO-A frequency and mode, IF filter selections, Clarifier on/off and offset settings, as well as Repeater Shift status (if appropriate). By default, the 99 regular memories are contained in one group; however, they can be arranged in up to 5 separate groups if desired.

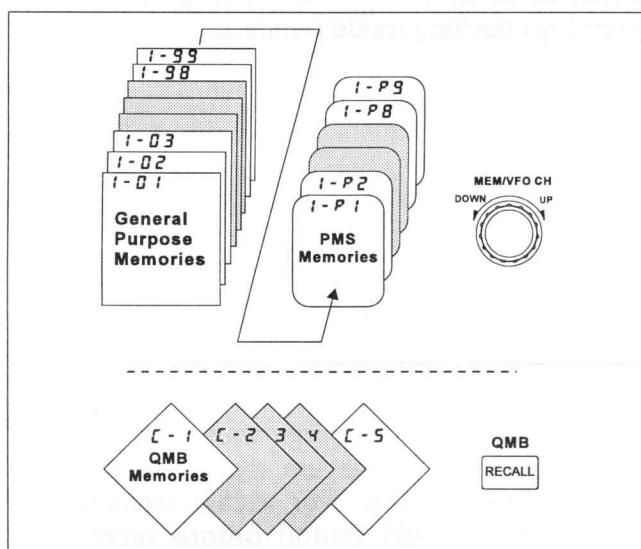

Like VFO operation, you can freely tune and change the mode or clarifier settings and you can also copy settings from one memory to another. In fact, you can do nearly anything with a memory that you can with the VFOs, except for the special PMS memories (P1~P9), described later.

The **VFO MEM**, **A-M**, **M-A** and **MCK** buttons are used to control various memory operations, as follows:

- **VFO MEM** - This toggles between memory or VFO operation. If a displayed memory has been re-tuned, pressing **VFO MEM** once returns to the original memory contents, and pressing it again returns to the last-used VFO.
- **A-M** - When receiving on a VFO or re-tuned memory, holding this for 1/2 sec. writes the current operating data to the currently selected memory. Two beeps sound, and any previous data in memory is overwritten. Momentarily pressing this activates memory checking (**MCK** blinks) for 3 seconds. This is described in the next section on memory storage and recall.

**M-A** - Pressing this for 1/2 second copies the frequency and operating data stored in a selected memory into the VFO. Momentarily pressing this activates memory checking (**MCK** blinks) for 3 seconds. This is described in the next section on memory storage and recall.

**MCK** - Pressing this activates memory checking (memory programming is next) and displays the contents of memory channels in the right SUB VFO-B display.

### Memory Programming

Memory programming allows storing your favorite or often-used frequencies into memory channels for long-term storage and quick recall. The FT-1000MP memories are retained after power-off by a long-life lithium backup battery that should not need to be replaced for more than 5 years. Should you expect to not use your transceiver for extended periods, you can switch off the backup battery via the rear panel switch to conserve lithium backup battery life (see page 101).

#### Copying VFO-A Data to Selected Memory

You can store the frequency and all operational settings for the displayed VFO into a memory channel by following this simple procedure:

- Set up all operating parameters and frequency as desired on MAIN VFO-A.
- Rotate the **MEM/VFO CH** knob to select the memory channel to fill (**MCK** will start blinking).
- Then, within 3 seconds (**MCK** still blinking), hold **A-M** for 1/2 second so that two beeps sound. The VFO contents are now stored in the selected memory channel and you are left operating on the VFO.

#### Copying a Selected Memory to VFO-A

Likewise you can store the frequency and all operational settings for the selected memory channel into MAIN VFO-A.

#### Auto Channel-Up

Normally, you must manually increment the channel number when programming consecutive memories. If you would like to save time and have the channel number automatically increment after writing each memory, this can be enabled in menu selection 0-8.

## Operation

- ❑ Rotate the **MEM/VFO CH** knob (**MCK** *blinks*) to select the memory channel to copy.
- ❑ Hold **M-A** for ½ second so that two beeps sound. The memory channel data is now copied to MAIN VFO-A, and you are left operating on the VFO.

### Memory Checking

Before storing or recalling a memory, you will usually want to check its contents. One memory channel number is displayed at all times (just to the left of the CH indicator at the right center of the display). You can change the selected channel number by rotating the **MEM/VFO CH** knob.

If you rotate this knob while receiving on the VFO or a re-tuned memory, **MCK** *blinks* beneath the channel number, and the mode and frequency previously stored in the selected channel will be displayed in place of the SUB VFO-B display. For three seconds after you stop turning the knob. If the memory is vacant, **CLEAR** appears above the channel number and nothing is displayed except two decimal points.

You can also view memories by pressing **MCK**, in which case memory data is continuously displayed (**MCK** remains on and doesn't blink). You must press **MCK** again to return the display to the VFO.

Momentarily pressing either **A-M** or **M-A** also activates memory checking. As mentioned before, **MCK** blinks as the frequency and mode indicators change to show the contents of the last-selected memory. If you touch nothing else, the display reverts to your current operating pa-

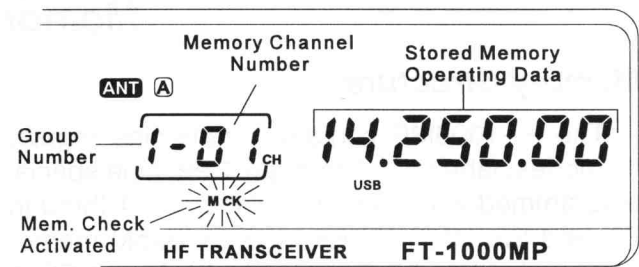

rameters automatically after 3 seconds. By turning the front panel **MEM/VFO CH** knob before the 3 seconds expires, you can select for display each of the general purpose and PMS memories. Pressing these buttons restarts the 3-second timer, so as long as you are changing channels, memory checking mode persists.

**Note:** When checking memories, both vacant and filled memories are displayed. If you would like to skip over vacant memories, press the **FAST** button before memory checking.

### Basic Memory Storage Procedure

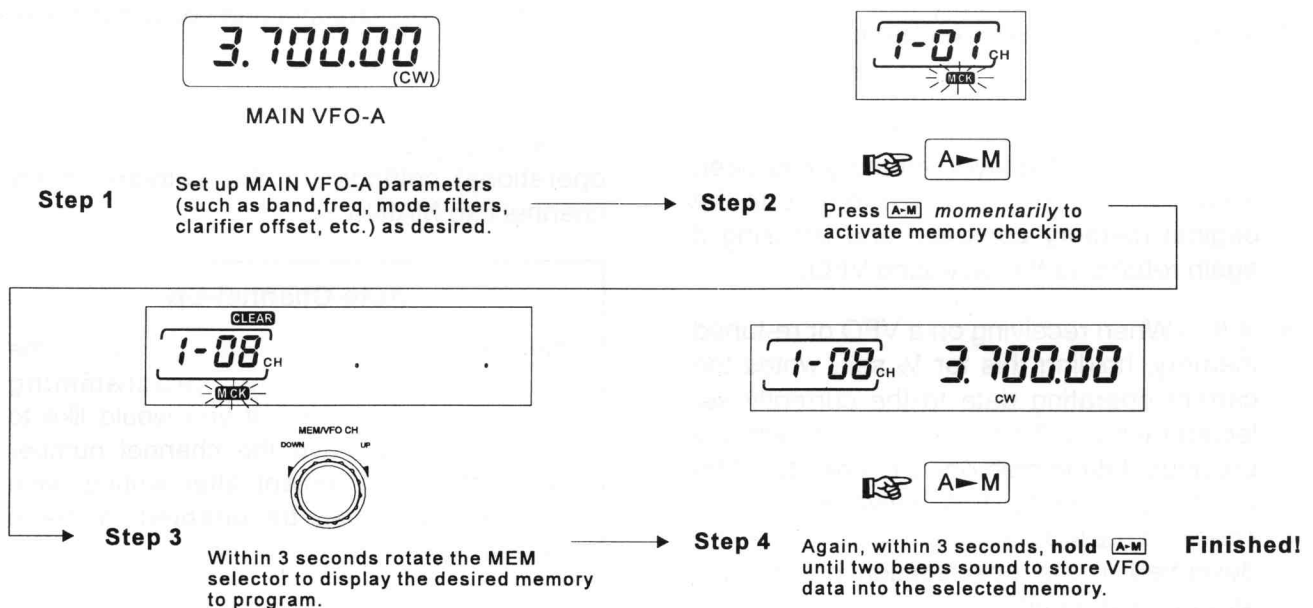

### Grouping Memories

The 99 regular memories and PMS memories P1~P9 can be grouped among up to five memory banks, if desired. Memory grouping is configured by menu functions 0-1 through 0-5.

By default, Group 1 is filled with all memories; Groups 2~5 are disabled (empty). Group 2 is enabled by not filling group 1 to capacity, and carrying over the extra memories, and so on. You could fill Group 1 with memories 1~20, for example, and carry over memories 21~99 & P1~P9 to Group 2, or else you can apportion them among Groups 2~5, as desired. Remember that to carry over memories from one group to the next, *the preceding group must not be filled to capacity* (i.e., the group holding memory channel P9 is the *last enabled group*).

### Recalling & Operating on Memory Channels

To recall data stored in a memory for operation, you can copy it into the VFO, or else switch from VFO to memory operation by pressing **VFO MEM**. Since you can freely tune any memory, copying it to the VFOs only gives you the advantage of **VFO** display indication.

Holding **M-A** for ½ second copies the current memory channel data into VFO-A. Pressing it only *momentarily* shows you the contents of the memory, without overwriting VFO-A data. Otherwise, when you press and hold **M-A**, you lose the previous contents of VFO-A, and if you were receiving on the VFO, operation shifts to the frequency and mode just copied from the memory.

In most situations, it is convenient to switch from VFO to memory operation by pressing **VFO MEM**. This method allows you to leave any VFO settings undisturbed, so you can instantly recall them just by pressing **VFO MEM** again.

When actually operating on a memory (if you haven't yet re-tuned it), the **MEM** indicator is displayed instead of **VFO**, and you can rotate the **MEM/VFO CH** knob or press the microphone **UP/DWN** buttons to select any previously-stored memories for operation.

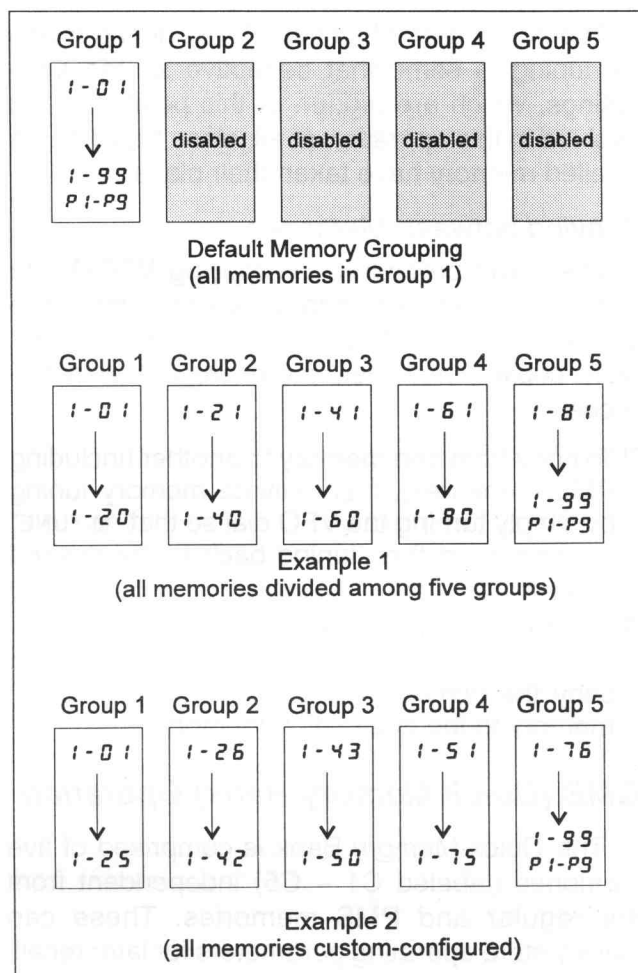

### Memory Tuning

With this mode, you can emulate VFO tuning and operation on a memory channel and retain the memory checking feature: if you change frequency, mode or clarifier settings, "MEM" is replaced with "M TUNE". During *memory tuning*, the microphone **UP/DWN** buttons now duplicate tuning knob functions like VFO operation (rather than select memory channels as before). Pressing **VFO MEM** once cancels any re-tuned changes to the memory and reverts to the memory recall mode ("MEM" displayed again). Pressing **VFO MEM** once more returns to VFO operation.

Memory Tuning makes operation on memories 1 to 99 just as flexible as the VFOs (memories P1 ~ P9 have special additional features, described later). If you want to save changes to a re-tuned memory channel, use the same procedure you use to store the VFOs to memory: Press **VFO MEM** momentarily and rotate the **MEM/VFO CH** knob to select another memory (if desired), or just hold **A-M** for ½-second until the double beep sounds (to overwrite the current memory with the re-tuned data).

## Operation

The labeling and function of **[A-M]** during memory tuning is somewhat deceptive as the VFO settings, which are hidden at this point, are not involved in this operation at all, since those of the recalled memory have taken their place.

### Copying between Memories

The same procedure for copying VFO-A into memories is also used to copy one memory to another. Like VFO-A, one memory can be selectively copied; however, there are a few differences.

- To copy from one memory to another (including PMS memories), first activate memory tuning by simply turning the VFO dial so that "M-TUNE" appears (and then tuning back to the desired frequency).
- Rotate the **MEM/VFO CH** knob to select a memory to fill, then (within 3 secs.), press **[A-M]** to copy the contents from the re-tuned (source) memory to the destination memory.

### QMB (Quick Memory Bank) Operation

The Quick Memory Bank is comprised of five memories (labeled C1 ~ C5) independent from the regular and PMS memories. These can quickly store operating parameters for later recall. You might find this handy to use when you have tuned a station of interest that you want to save, but don't want to overwrite your regular or PMS memories, especially if you have them organized a specific way.

You can use the QMB memories the same way you would a notepad in your shack - for jotting down (saving) frequencies and modes to come back to later. There are five QMB memories enabled by default; however you can disable some if desired, using menu selection 0-6.

- To copy settings into the first Quick Memory (C-1), simply press **[STO]**.
- Stored Quick Memories are recalled by pressing **[RCL]** repeatedly to select the desired memory (**QMB** displayed at the left and Quick Memory channel number is displayed in the memory box, as shown below).

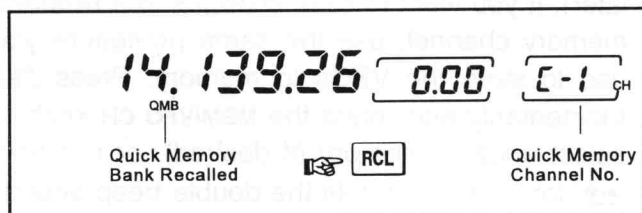

Additional settings are entered directly into C-1, with previously stored entries shifted to the next available Quick Memory. This "stacking" system keeps the most recent entry in the first memory, and automatically shifts older entries into the next consecutive memory. After all Quick memories have been filled, additional entries overwrite previous ones on a "first-in, first-out" basis (as shown inside the box below).

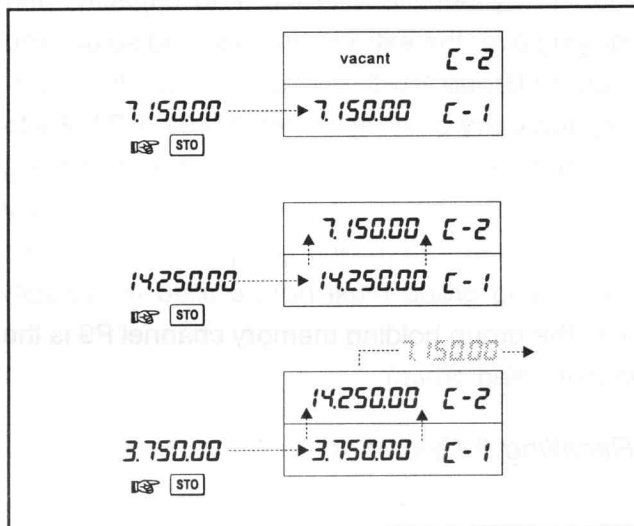

- To revert from QMB operation back to VFO-A, simply press **[VFO MEM]** once.

### Limiting Memory Group Operation

If you have assigned filled memories into more than one group (as explained on the previous page), you can enable a particular group and limit memory recall and scanning operation (covered later) only to those memories in that selected group, if so desired.

To do this, simply rotate the **MEM/VFO CH** knob so that any memory channel number in the desired group is displayed, then press the **MEM GROUP** button just above and to the left (see box below). The **GROUP** indicator appears and you will find that only memories within that group are now available for recall and operation.

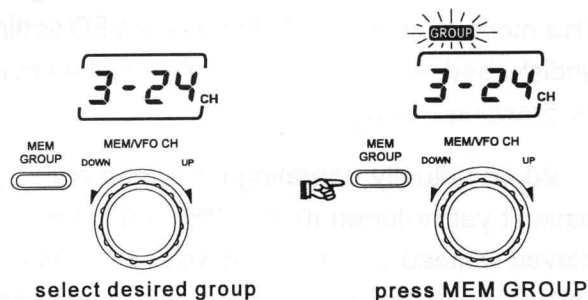

## Scanning Features

### VFO Scanning

You can start scanning on MAIN VFO-A by holding the microphone **UP** or **DWN** button for 1/2 second (the receiver squelch does not have to be closed in this case). To increase the scan speed (x10) press either the microphone **FST** button (momentary-type) or the front panel **FAST** button. Scanning continues up or down until a button is pushed, or else “loops-around” when the upper or lower receiver limits are reached.

Scan speed is determined by the receiver “dwell time” using menu function 2-4. Dwell time is the duration that each channel is sampled for activity as the receiver scans up or down and is adjustable from 1 msec (fast) to 100 msec (slowest). Try experimenting with different durations until you reach the desired scan rate.

### Memory Scanning

The 99 memories in the FT-1000MP offer some choices regarding how they are scanned, and, after the following brief description, you can decide how to tailor scanning for your operating needs.

When receiving on a recalled memory (with **MEM** displayed), you can scan all stored memories by just holding the microphone **DWN** or **UP** button for 1/2 second to start. If you want scanning to pause on signals, you must first adjust the **SQL** control to silence the receiver (green **MAIN BUSY** indicator off) on a clear channel. Scanning pauses on any channel having a signal strong enough to open the squelch, and the two decimal points in the frequency display blink. You may need to readjust the **SQL** control to prevent scanning from stopping on only background noise. Scan speed is not affected by the microphone or panel **FAST** buttons, but is configured by menu selection 2-3. The memory scanning “dwell time” is adjustable from 100 (fast) ~ 1000 msec (slow).

To stop scanning, press the PTT switch (no transmission will occur), or a microphone button again. When scanning, keep in mind that the **IPO** and **ATT** selections also affect the squelch threshold by changing receiver front-end sensitivity.

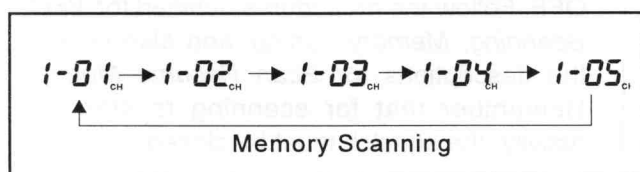

### Scan Resume Mode

There are three choices that determine how scanning will respond when activity is detected. Scan resume operation is configured by recalling menu selection 2-1, and choosing the desired mode. Below is an outline of each scan resume mode and how it operates.

**Carrier Stop** (default) - With the squelch closed, scanning pauses on signal activity, then resumes soon after the carrier disappears. With the squelch open, scanning will not continue unless the receiver is quieted again (**SQL** control).

**Carrier Timed Stop** - With the squelch closed, scanning pauses on activity, then resumes automatically after a preset duration (5 seconds by default), *whether signal activity remains or not* (time-delay resume).

**Carrier Timed Slow** - With the squelch closed, scanning slows down (but doesn't stop) for a preset duration (5 seconds by default), when activity is detected.

For the Timed Stop and Timed Slow modes, the pause duration can be set between 1 and 10 seconds with menu selection 2-7, or else the scan pause (resume) feature can be disabled completely using menu selection 2-0. If disabled, scanning will not stop for any activity.

### Memory Scan Skip

By default, all programmed memories are included for scanning. However, you can “flag” some of them to be skipped while scanning. To do this, recall the memory you want to be skipped, and hold either front panel or microphone **FAST** button while pressing **MCK** momentarily so the “dash” between the group number and memory channel number disappears. If you have flagged a memory to be skipped, and later want to enable it again, just repeat the **FAST** + **MCK** procedure.

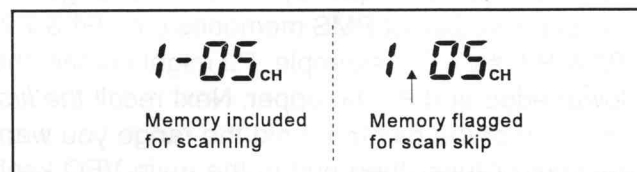

### Scan Skip Disable

After programming many memories, you may have tagged specific ones to be skipped during scanning. Should you later change your mind and want to scan all of them again, you don't have to go back and re-enable each tagged one (there's an easier way).

Recall menu function 2-6 and change the "Scan All" setting from off to on. The memory tags are still retained, but ignored when this setting is turned on. To return to selective scanning, simply change the setting to "off".

### Memory "Masking"

You may want to hide some memories from operation, to simplify selection of others. To mask a displayed memory, while **MEM** is displayed, press and hold **[A-M]** for ½ second until the double beep sounds. But be careful: if you do this instead while **MTUNE** is displayed - that is, after retuning the memory, the retuned data will overwrite the original memory data, but it will not be masked. So, if you have re-tuned the memory and don't want to save the changes, cancel them first by pressing **[VFO MEM]** once, and then hold **[A-M]** for ½ second. No frequency digits appear for masked memories - just the two decimal points remain.

Masked memories are also skipped during scanning. If you don't overwrite a masked memory, you can unmask it simply by repeating the same procedure you used to mask it.

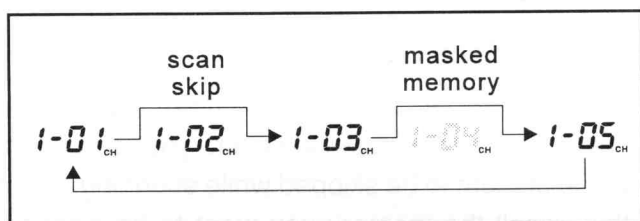

### Programmed Memory Scanning PMS Memories P1 ~ P9

To limit scanning (or tuning) to within a *particular frequency range*, you can use Programmed Memory Scanning (PMS) provided with nine special-purpose memories (P1 ~ P9). First, store the upper and lower frequency limits of the range in a *consecutive pair* of PMS memories (i.e., P1 & P2, P2 & P3, etc). For example, P2 might contain the lower edge and P3 the upper. Next recall *the first memory of the pair* that hold the range you want to scan or tune, then nudge the main VFO knob

to activate memory tuning (**PRGM** appears). Tuning and scanning are now within the limits of the selected PMS memory pair, keeping operation inside this programmed range.

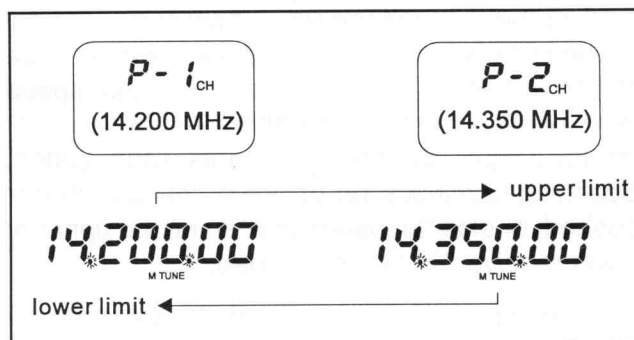

Ex: Limit tuning & scanning to the 17-m band.

- Press **[VFO MEM]** as necessary, to display **VFO**. Tune to the low edge of the 17-m band: 18.068 MHz and select the desired mode (here, USB/ CW).
- Rotate the **MEM/VFO CH** knob and select memory P1. Then (while **MCK** is still blinking) hold **[A-M]** for ½ sec. to write the VFO into P1.
- Press **[VFO MEM]** to select the VFO, tune to the high edge of the 17-m band (18.168 MHz), then select the desired mode.
- Rotate the **MEM/VFO CH** knob, then select memory P2. Hold **[A-M]** for ½ sec. to write the VFO into P2. Now recall memory P1, and turn the tuning knob (to activate memory tuning).

Tuning and scanning are now limited to the 18.068- to 18.168-MHz range until you press **[VFO MEM]** to return to memory channel operations, **[A-M]** to copy the displayed frequency to a memory, or **[M-A]** to write the displayed frequency to a VFO.

### Auto Memory Write

While scanning the VFO or a retuned memory, you can have the FT-1000MP automatically write active channels into memories for later recall and scanning. As scanning pauses on activity, frequency information is written into available memories in Group 1, or all enabled groups, until full. You can leave scanning unattended, if desired, then return later to recall and check memories for station activity.

To enable this feature, recall menu function 2-5, and select GROUP 1, ALL GROUPS, or OFF. Follow the procedures outlined for *VFO Scanning, Memory Tuning*, and also review the descriptions for *Scan Resume Modes*. Remember that for scanning to stop on activity, the squelch must be closed.

## Digital Modes with the FT-1000MP

The FT-1000MP offers special features for digital modes, such as a built-in digitally-synthesized AFSK generator for RTTY and AMTOR terminal units, IF bandwidth optimization and automatic display offsets, and an 18-ms transmit-to-receive turn-around time. Note that the Sub VFO receiver bandwidth is selectable between 6.0 kHz, 2.4 kHz and 500 Hz (optional YF-115C required) in the RTTY and PKT modes.

Low-level *Main Receiver* audio output is provided from the rear-panel **RTTY** and **PKT** jacks, and is unaffected by front panel volume control settings. If you prefer to use *Sub Receiver* audio for TNC input, switch **S3001** (located on the AF UNIT PCB between the **DVS-2** and **PKT** connectors) can be moved from the MAIN to the SUB position.

Audio level is 100 mV from both jacks. The RTTY level is fixed; however, PKT audio level can be adjusted by **VR3010**. In many cases, it is easier to perform level adjustments at the TNC.

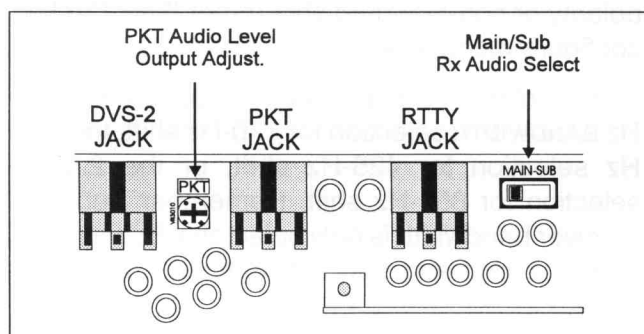

### RTTY and AMTOR with a TNC

First determine if you will be using FSK or AFSK operation with your TNC. Check with the TNC documentation to determine if FSK operation is possible. With FSK operation, the FT-1000MP generates the mark and space tones; when using AFSK keying, your TNC will generate the mark and space tones instead. Construct a patch cable between your TNC and the appropriate rear panel jack (**RTTY** for FSK, **PACKET** for AFSK). Refer to the pin-out diagram below, and the wiring instructions included with your TNC.

Connect your TNC to the jack you will use on the rear panel, as shown below. Also, configure RTTY menu selections 6-0~6-3 for the shift, polarity, tone pair and display offset you will use. The default settings for these selections are the most common ones used, but may differ depending on your operating requirements. A brief description of RTTY-associated settings are listed below.

**RTTY Shift** - Menu selection 6-0 chooses the frequency shift between mark and space tones. Amateur RTTY uses 170 Hz by convention, 850 Hz for MARS and other services.

**Important Note!** - if changing shift to other than 170 Hz, be sure to re-calibrate the tuning meter as outlined on page 72. The calibration routine is simple, and ensures your center tuning indication matches the new shift (tone pair).

### Station Interconnections for Digital Modes

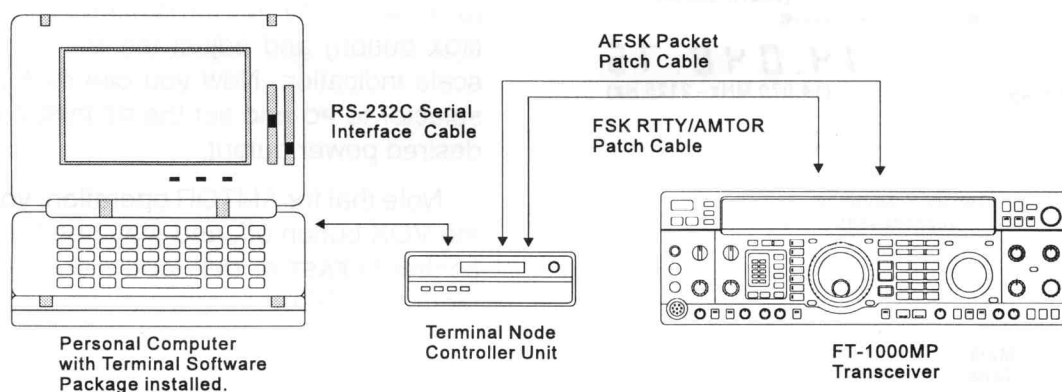

#### PACKET (AFSK)

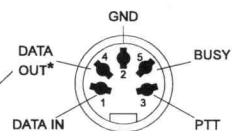

\* Level adjustable via VR3010.

#### DIN Plug Connections

Both jacks pin-outs appear as viewed looking at the rear panel.

#### RTTY (FSK)

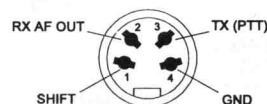

## Operation

**RTTY Polarity** - Normally a mark tone (2125 Hz by default) is transmitted during keydown in *LSB* RTTY operation. With reverse polarity, a space tone (2295 Hz) would be generated instead. Polarity is changed using menu selection 6-1.

**RTTY Tone Pair** - Select either high or low tone-pair operation using menu selection 6-2. If you are using the same modem for both VHF and HF operation and cannot software-select the tone pair needed for each band, you may want to consider using the low tone pairs.

RTTY Tone / Shift Information				
Shift	High Tone Pair*		Low Tone Pair	
	Mark	Space	Mark	Space
170 Hz*	2125 Hz	2295 Hz	1275 Hz	1445 Hz
425 Hz	2125 Hz	2550 Hz	1275 Hz	1700 Hz
850 Hz	2125 Hz	2975 Hz	1275 Hz	2125 Hz

\* indicates default setting (used by normal convention)

**RTTY Frequency Display Offset** - By default, the frequency displayed on the front panel during RTTY operation is *the frequency of the mark signal*, but if you prefer to display the (suppressed) carrier frequency, use menu selection 6-3.

### Display Offset for RTTY Operation

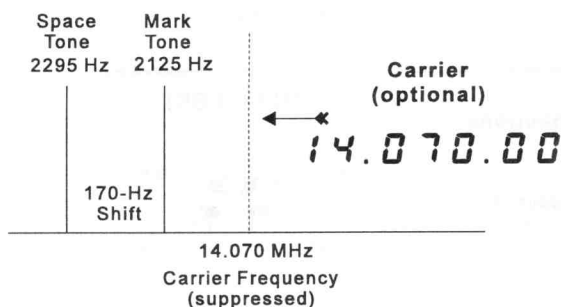
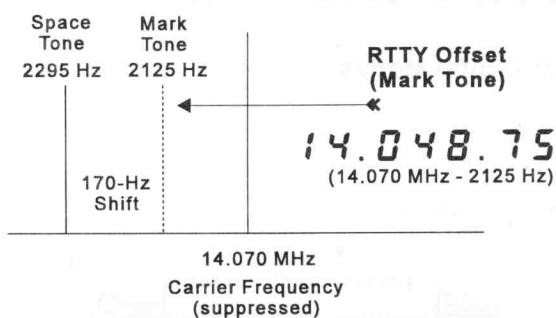

### CAUTION!!

The FT-1000MP cooling system is designed to handle continuous duty transmission at 100 watts output. However, for RTTY, we recommend limiting your transmissions to 3 minutes or less, with at least 3 minutes receive in between transmissions (or use an external linear amplifier). Place your hand on the transceiver occasionally to ensure that it's not getting too hot and try to keep power output at 50 watts or less.

You can limit the maximum RF power output to 50 watts via programming, by recalling menu selection 4-0 and choosing either full or reduced power output.

### RTTY Operation

To operate, just press the **RTTY** mode button once or twice to select the desired sideband for operation. *LSB* is default, and is used by normal convention (*USB* can be selected for MARS or other applications). Should you need reverse tone polarity or non-standard shift (other than 170 Hz), configure menu selection 6-1 and 6-2 as desired.

For optimum signal-to-noise ratio, use the 250-Hz **BANDWIDTH** selection for 170-Hz shift, the 500-Hz selection for 425-Hz shift, or the 2.0-kHz selection for 850-Hz shift. Remember Sub VFO receiver bandwidth is only selectable between 6.0 kHz, 2.4 kHz and 500 Hz (optional YF-100 required) for RTTY and PKT.

Before transmitting, preset the **RF PWR** control fully counter-clockwise, and set the **METER** selector to **ALC**. Key the transmitter (you can use the **MOX** button) and adjust the **MIC** control for mid-scale indication. Now you can switch the **METER** selector to **PO** and set the **RF PWR** control for the desired power output.

Note that for **AMTOR** operation, you must have the **VOX** button off, and may need to set the **AGC** control to **FAST** or **OFF** (and reduced RF Gain for Mode A (ARQ)).



### 300-Baud Packet

Construct a patch cable as required, and connect your TNC to the rear-panel **PACKET** jack. Do *not* connect the squelch line (pin 5) for 300-baud packet operation.

Tuning is very critical for F1 packet: you should tune the transmitter and receiver within 10 Hz of a signal to minimize repeats. The FT-1000MP includes a few custom features to make packet operation more convenient.

**Packet Tone Pair** - This offsets the *center of the IF bandpass* according to the packet tone pair you are using. If set correctly, the receiver pass-band will remain centered on a properly-tuned packet station when switching between wide and narrow IF filters, minimizing the need for re-tuning or use of the **SHIFT** control for re-centering.

One of four standard tone pairs can be chosen for operation from menu selection 6-5, as desired. The menu display shows the *center* frequency of the selected tone pair (see the table below for actual mark/space tone combinations). Set the Packet Tone Pair to match the tones generated by your TNC (these are usually set via terminal software or DIP switches—check in your TNC documentation).

Packet Tone Information	
TNC Tone Pair	Tone Center Frequency
1070/1270 Hz	1170 Hz
1600/1800 Hz	1700 Hz
2025/2225 Hz*	2125 Hz*
2110/2310 Hz	2210 Hz

\* indicates default setting (used by normal convention)

**Important Note!** - if changing packet tone pair to other than 2025/2225 Hz, be sure to re-calibrate the tuning meter as outlined on page 72. The calibration routine is simple, and ensures your center tuning indication matches the tone pair.

**Packet Frequency Display Offset** - You can display the center frequency of the two transmitted carriers, (that is, the packet tone pair used), without any offset, instead of the actual carrier frequency. Recall menu selection 6-4 and turn the main knob to select the offset ( $\pm 3.000$  kHz).

**Note** - The default display offset is -2.125 kHz (to match the default tone pair\* in 6-5 above, and assuming LSB operation). Ideally, the display off-

### Display Offset for Packet Operation

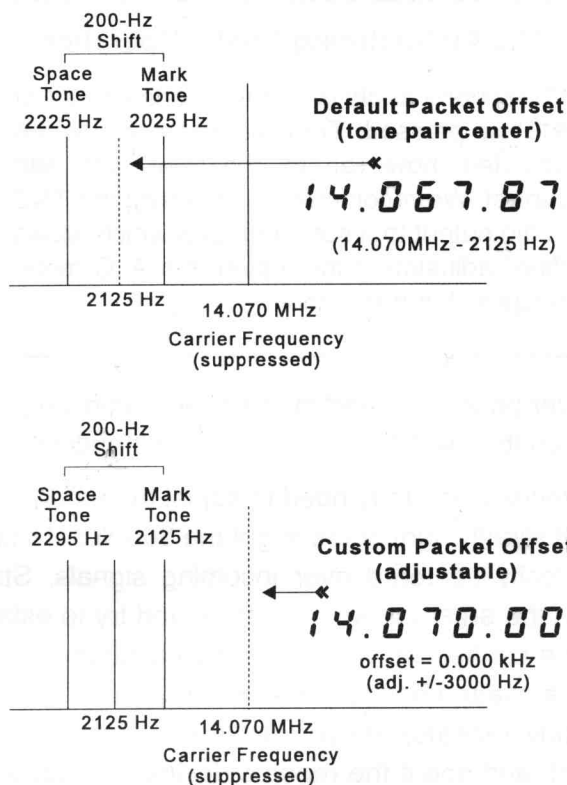

set should match the default tone pair, which in turn should match those used by your TNC. If you would rather have the actual carrier frequency (without offset) displayed, set the display offset to 0.000 kHz.

### Packet Operation

- Select the 500-Hz **BANDWIDTH** filter for 300-baud packet, and press the **PKT** mode button on the front panel once or twice, so that the green **LSB** LED indicator lights along with the orange **PKT** LED.

Transmitter adjustment is similar to SSB:

- Preset the **RF PWR** control counterclockwise, and set the **METER** selector to **ALC**.
- Now set your TNC to its "calibrate" mode, preferably with both tones alternating, and adjust the **MIC** control so that the meter deflects to mid-scale.
- Switch the **METER** selector to **PO** and advance the **RF PWR** control for the desired power output.

When tuning, be aware that some common HF packet channels, such as "14.103" MHz, were originally determined to correspond with an actual IF center frequency 1700 Hz lower (in accordance with an old TAPR convention). Therefore, if you have the Packet Frequency Display Offset (6-4) set to match your TNC's actual tones, the display shows 14.101.30 when tuned to the above frequency — which is the actual center of your re-

### Mic Audio during Digital Operation

Microphone audio is muted whenever **PKT** or **RTTY** is pressed. Transmit audio gain is still adjusted, however, by the front-panel **MIC** control. We recommend first setting the TNC audio output to a sufficient level which allows "fine" adjustment throughout the ALC meter range with the **MIC** control.

ceiver passband, and the frequency mid-way between the two FSK carriers you will transmit.

Initially, you may need to adjust the receiver IF shift slightly right or left to get the 500-Hz IF filters perfectly centered over incoming signals. Start with the **SHIFT** control centered, and try to establish a connection with a moderately strong signal on a clear channel. If the connection is poor (many repeats), move the **SHIFT** control slightly right, and see if the repeats decline. Continue in this manner until you find the best **SHIFT** setting (with minimal repeats), and use this same setting for all future HF packet operation.

### 1200-Baud FM Packet

The equipment setup for 1200-baud FM packet (above 29 MHz) is the same as for 300-baud packet, except that you may want to connect the squelch line of the TNC to pin 5 of the **PACKET** jack if you plan to use the squelch. Press the **PKT** mode switch until both it and the green LED on the **FM** mode button are lit. Tuning is much less critical in this mode, requiring no special adjustments. Also, the **FM MIC GAIN** control in the top access panel has been preset at the factory for proper deviation with typical signal levels, so you should not need to readjust it (you should adjust the Tx audio output level of your TNC, though, if your signal sounds distorted in the monitor).

To set up the transmitter for FM packet:

- Start with the **RF PWR** control counterclockwise, and set the **METER** selector to **ALC**.
- Set your TNC to its "calibrate" mode, preferably with both tones alternating, and adjust the **MIC** control so that the meter deflects to mid-scale.
- Switch the **METER** selector to **PO** and set the **RF PWR** control for the desired power output.

### Note: Computer-Generated RFI

When using a TNC connected to your transceiver, or even having a PC located in the shack, the possibility exists that you may experience computer-generated RFI (Radio Frequency Interference).

The CPU in a personal computer operates with a crystal-controlled oscillator (clock) and timing circuits. Common clock frequencies include 8, 12, 16, 20 and 25 MHz. In addition, high-speed digital data switching uses square waves, which produce odd-order harmonic frequencies.

Computer-generated RFI may appear at seemingly random frequencies (usually right where a rare DX station is calling CQ!) throughout the range of your transceiver, and may sound like constant ticking or buzzing that may change as you type or work within a program. Severe RFI may have S-meter indications as much greater than S-9, making copy of voice signals difficult and data signals virtually impossible.

Computer-generated RFI is usually a result of inadequate shielding of the PC's cabinet or I/O and peripheral connections. While computer equipment may comply with RF emission approval standards, this does not ensure that sensitive amateur radio receivers will not experience RFI from the device.

There are a few steps you can take to reduce or eliminate computer-generated RFI. The first step is to ensure that only shielded cables are used for TNC-to-transceiver connections, carefully check RF ground connections and re-orient your station equipment in relation to the computer. Try moving your PC and peripherals slightly and see if it has any affect on the RFI, in some cases, this alone may be enough to correct the problem.

If not, several additional steps to try include installing AC line filters on the power cord(s) of the suspected equipment and inserting decoupling ferrite toroidal chokes on interconnecting patch/data cables and smaller ferrite beads on single wires.

As a last resort, you can try installing additional shielding within the PC case, using appropriate conductive mesh/screening or conductive tape. Especially check RF "holes" where plastic is used for cabinet front panels. For further information, consult amateur radio reference guides and publications relating to RFI suppression techniques.

## Advanced Features

### EDSP

Enhanced Digital Signal Processing uses A/D (Analog to Digital) & D/A (Digital to Analog) conversion techniques under microprocessor control to achieve total enhancement of signals at the audio (rather than IF) level. The major capabilities offered by EDSP lie in the area of heterodyne/random noise reduction and audio bandpass filtering. Digital filters have many advantages over their analog counterparts in that they can meet tighter specifications on parameters such as voltage and temperature drift and noise problems.

The FT-1000MP uses a 16-bit, state-of-the-art NEC  $\mu$ PD77016 CMOS digital signal processor chip featuring a 30-nS Instructions Cycle, 33 MHz Clock frequency, a 16 x 16-bit and 40-bit multiply accumulator, 40-bit Barrel Shifter, and 64 K Bytes Program ROM.

DSP enhancement is basically a four-step process. Audio input is sampled several thousands of times per second, then the frequency and amplitude of the audio are converted into a digital representation of the analog waveform that resembles ascending and descending "staircases" by the A/D (analog-to-digital) converter. This is later changed into digital serial bitstream as raw data for analysis and processing.

Information is extracted from digital data, and the EDSP chip performs complex mathematical calculations according to pre-programmed routines known as algorithms. Algorithms are proc-

essed then compared against a set of parameters (or threshold if you will) based on a phenomenon known as "correlation". The degree of correlation depends on the type of audio: random noise has relatively little correlation, speech contains moderate correlation, with heterodynes (and QRM) being highly correlated. The EDSP microprocessor is programmed with various parameters corresponding to different known audio phenomena.

EDSP allows the frequency spectrum of a received signal to be modified according to a specific set of parameters for the desired effect (QRM reduction, audio tailoring, etc.). Certain types of audio interference leave a distinctive signature or "footprint", which can be recognized, and "processed out" of the digitally-reconstructed audio from the EDSP chip. Also, digital filters are constructed which emulate traditional low-pass, high-pass, band-pass, and band-stop filters, except with steep skirt shaping and performance possible with digital technology. EDSP also allows direct "digital" demodulation of audio for receive, as well as direct modulation of audio for transmit.

### Introduction

#### EDSP Functions

The EDSP circuitry in the FT-1000MP allows digital enhancement of both transmitted and received audio. A basic primer on DSP was given to inform you more about this capability than just the panel label and button location. Now you can customize its filtering capabilities and use it to reduce QRM and tailor audio response for each operating mode.

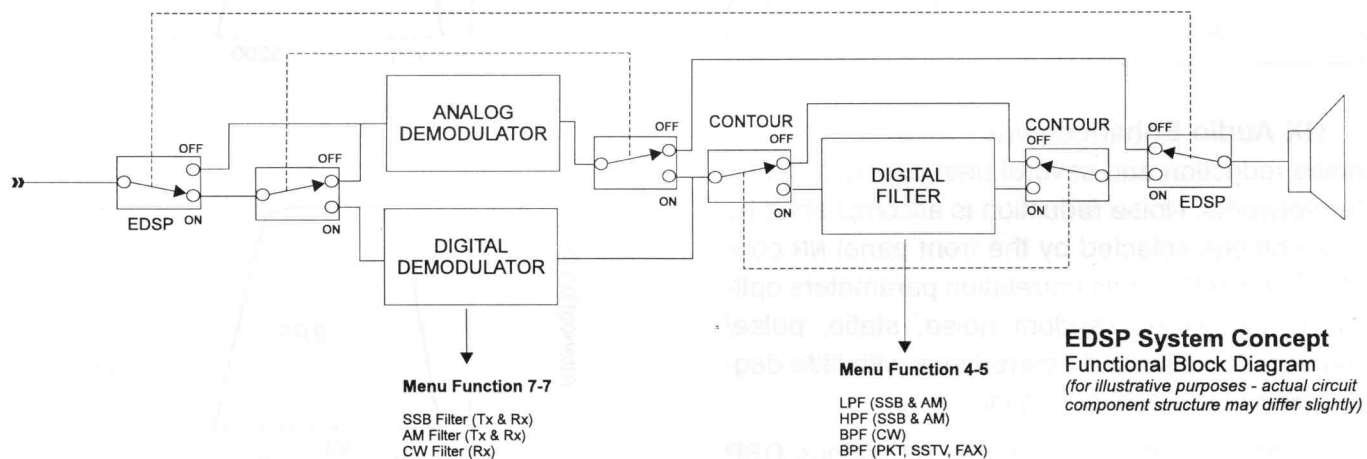
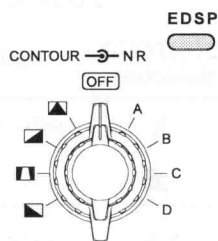

**EDSP System Concept Functional Block Diagram**  
(for illustrative purposes - actual circuit component structure may differ slightly)

## Operation

**TX Audio Enhancement** - Four microphone audio responses can be chosen using menu selection 4-4. Since audio characteristics voice vary between people, these settings enable tailoring your transmitted audio for best clarity.

**TX IF Filter Selection** - Normally, both 2.4 kHz filters are selected in the transmit IF chain. However, with EDSP operation, you can select 6.0 kHz filters for wider frequency response on transmit audio. The effect of this filter selection is directly related to menu selection 7-7 (below). The desired filter is chosen with menu selection 5-9, and is only active when EDSP is turned on.

### EDSP Modulation and Demodulation

**TX EDSP Modulation** - Early-stage transmitted SSB audio is applied directly to EDSP circuitry for processing. EDSP filter parameters can be matched to voice characteristics for optimum audio tailoring and sound effect.

**TX EDSP Demodulation** - For SSB, CW and AM, receiver 3rd IF output is applied directly to EDSP circuitry for demodulation and processing. Bypassing conventional filters and utilizing EDSP digital filter offers optimized bandwidth and frequency response.

Menu selection 7-7 configures the settings for both Rx and Tx EDSP (see table below).

EDSP Modulation and Demodulation Menu Selection 7-7	
Mode	Settings
SSB (Rx)	OFF 100~3100 Hz 300~2800Hz
SSB (Tx)	OFF 100~3100 Hz 150~3100Hz 200~3100 Hz 300~3100 Hz
CW (Rx)	OFF ON (100~3100 Hz)
AM (Rx)	OFF ON (70~3800 Hz)

**RX Audio Enhancement** - EDSP offers both noise reduction and several user-configurable filter networks. Noise reduction is accomplished by four settings selected by the front panel **NR** control. Each setting has correlation parameters optimized to reduce random noise, static, pulse/man-made noise and heterodynes with little degradation of the desired signal.

QRM reduction is enhanced by various DSP filter networks. The front panel **CONTOUR** control

selects low-, mid- and high-cut filters along with a band pass filter (see below).

EDSP CONTOUR Selections		
CONTOUR Selection	Filter Type	Application
	BPF (Band -Pass)	QRM rejection
	LCF (Low - Cut)	high-freq. emphasis
	MCF (Mid - Cut)	high & low freq. emphasis
	HCF (High - Cut)	low-freq. emphasis

The low-, mid-, and high-cut filters are pre-set for different audio emphasis. The bandpass filter, however, is used for QRM rejection and can be user-tailored for SSB, CW, AM and Digital operation. The lower and upper frequency cut-off of each mode-respective BPF is adjusted by menu selection 4-5, With the **CONTOUR** control set to the BPF () position, the low- and high-cutoff settings for the bandpass filter are selected automatically as you change modes. See the illustration below and the table at the top of the next page for filter and cut-off ranges.

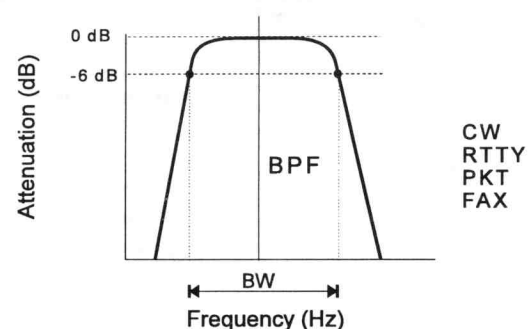
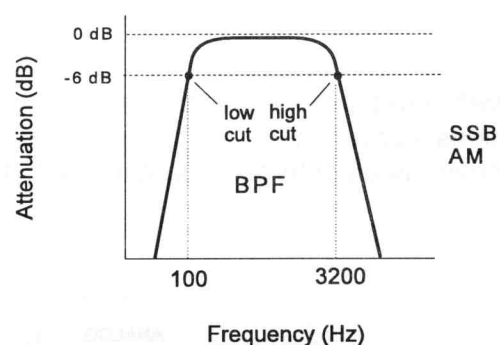

EDSP BPF Selection & Parameters Menu Selection 4 - 5			
Mode	BPF	Cutoff Range (Hz)	Default Cutoff (Hz)
SSB	High Cut	1000 ~ 4500	3200
	Low Cut	100 ~ 1800	100
CW	Bandwidth	60/120/240	240 (BW)
AM	High Cut	1000 ~ 4500	3200
	Low Cut	100 ~ 1800	100
DIGITAL	PKT	800 ~ 2500 Hz, preset	
	SSTV	1000 ~ 2500 Hz, preset	
	FAX	1300 ~ 2500 Hz, preset	

Notch Filter Operation Menu Selection 2 - 9	
NOTCH Mode	Operation
MANUAL	Conventional, manually- controlled IF Notch
AUTO	EDSP Auto Multiple-Notch
SELECT	Selectable - with EDSP off, functions as manual notch, with EDSP engaged, auto multiple notch takes effect

**EDSP Auto Multiple Notch Filter** - On page 34, we previously discussed basic IF notch filter operation and how it is used to attenuate heterodynes. EDSP offers multiple-notch capability within the AF (rather than IF) bandpass with the press of a button.

With the conventional (455 kHz 3rd IF) notch filter, only a single offending heterodyne at a time can be attenuated by pressing the **NOTCH** button and slowly rotating the inner **NOTCH** control. Notch tuning can sometimes be critical, as you have to position the control for maximum "depth" by ear.

With the multiple notch, EDSP circuitry examines the AF bandpass and the correlation of the signals present. After correlation parameters are compared, unmodulated signals (heterodynes) are identified and notched out. As EDSP dynamically checks the audio, new heterodynes will be identified and notched, one by one, as they appear. See the illustration below.

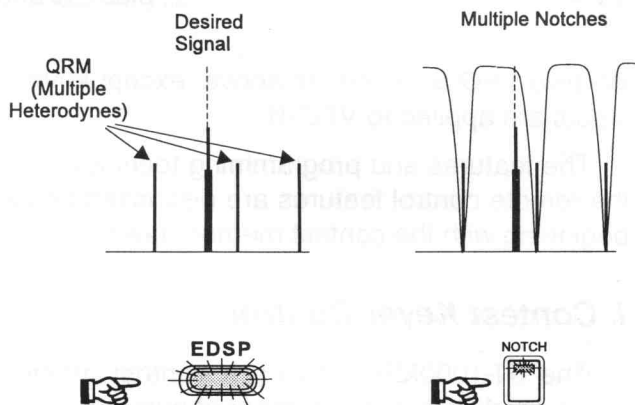

EDSP Auto Multiple Notch Action

Theoretically, an infinite amount of notches could be inserted to attenuate each new heterodyne; however, the total notch bandwidth would approach that of the audio passband, and, progressively notch all audio. One limitation of the EDSP auto multiple notch feature is that it is only for use with SSB modes.

It is important to realize that notch operation is determined by two things:

- The setting of menu selection 2-9.
- If EDSP is active or not when the **NOTCH** button is pressed.

The **NOTCH** button still activates the IF notch circuit, but you must determine which type of notch (manual or EDSP-auto) will take effect via menu selection 2-9 (see the box below). For the auto notch feature (and all other EDSP functions), the **EDSP** button *must be engaged* for signal processing to occur.

**Important Note About EDSP**

An advantage of EDSP is the flexibility for the user to customize or "tailor" received and transmitted audio. Menu selections 4-4, 5-9, and 7-7 each have distinct effects on the sound of your transmitted audio. The "ultimate" combination of these settings will of course vary between users personal taste, and for the desired effect (distinctive audio, QRM penetration, etc.).

The easiest way to immediately hear the effect of different EDSP settings is to use the transceiver's built-in MONITOR circuit to listen to your audio while transmitting. In this way, you can step through the various setting combinations, and select the ones that appeal the most to you, or the receiving station.

# Remote Control Operation

## Introduction

You can select and activate various transceiver functions via the optional FH-1 Remote Control Keypad (available from your Yaesu dealer) connected to the **REMOTE** jack on the rear panel of the transceiver. A remote-control keypad may also be built at home, utilizing the diagram and resistance/voltage chart below. When constructing your own keypad, use 0.5%, E96 (precision metal film) resistors so as to ensure that the precise voltages specified are generated.

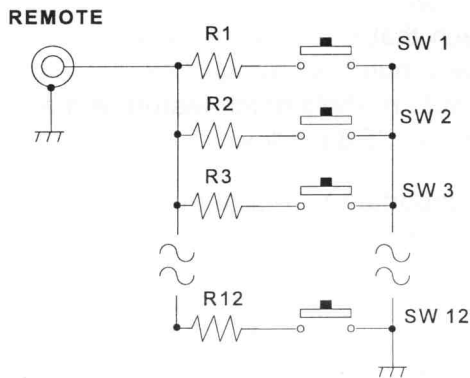

Remote Control Circuit

Remote control operation is provided by reading a voltage across a ladder resistor network in the keypad matrix as a key is pressed. Twelve distinct, precise voltages are used to activate the twelve available functions. The voltage chart below documents the required voltage for the corresponding key closure on the keypad.

Remote Control Voltage Level		
Key #	Voltage Level	Resistor Value $\Omega$
1	0.78 V	866
2	1.10 V	1330
3	1.40 V	1820
4	1.73 V	2490
5	2.04 V	3240
6	2.34 V	4120
7	2.66 V	5360
8	2.96 V	6810
9	3.27 V	8870
10	3.59 V	12000
11	3.91 V	16900
12	4.22 V	25550

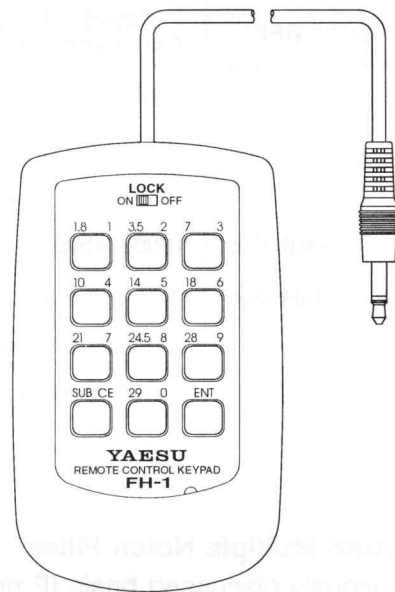

Four transceiver remote control features are available via Menu Selection 7-9. Once the desired remote control operating mode is selected, pressing a key activates one of the functions available in that operating mode; the function activated by a key closure might be a CW message playback, a contest number being incremented upward, or a front panel function being duplicated.

The four remote control features available are:

- I. Contest Memory Keyer** - the recording and playback of repetitive contest messages are accomplished via the keypad.
- II. VFO/Memory Function Control** - in this mode, the remote control keypad duplicates the front panel keys that relate to VFO/Memory selection and programming.
- III. Main VFO-A Control** - in this mode, the remote control keypad duplicates the functions of the front panel **BAND** keypad (keys  $\boxed{1.8}$   $\boxed{1}$  ~  $\boxed{29}$   $\boxed{0}$ , plus  $\boxed{SUB}$   $\boxed{CE}$  and  $\boxed{ENT}$ ) as applied to VFO-A.
- IV. Sub VFO B** - same as above, except keypad inputs are applied to VFO-B.

The features and programming techniques for the remote control features are discussed below, beginning with the contest memory keyer.

### I. Contest Keyer Control

The FT-1000MP includes a contest memory keyer which includes a number of automated features which reduce operator fatigue during long hours of contest operating.

## Features

The keyer offers six CW message memories that can be used to store your callsign and/or repetitive messages like "CQ TEST DE <callsign>" or "TU QRZ <callsign>." Additionally, a three- or four-digit contest serial number "001, 002...." may be imbedded into the first memory location for contest exchange use. The contest number can be incremented/decremented manually, reset to an arbitrary number (in the middle of a contest), and can also be played back using "cut" numbers ("5NN TT1, 5NN TT2..."), if desired.

Linear amplifier or external antenna tuner adjustment may also be assisted, thanks to the momentary **TUNE** key on the keypad. Via Menu, the tune-up power output may be limited to a maximum of 50 or 10 Watts, instead of the usual 100 Watts, and #12 key serves as a momentary (push and hold) key which activates the transmitter and puts out a carrier for tuning purposes.

Let's now look at the storage and recall capabilities of the contest memory keyer.

### 1. Contest Number Memory

The #1 key allows storage of a message of up to 20 characters in length. Within this message, a contest sequential serial number may be imbedded during the programming process by sending "???" (three Question Marks) in the place where the contest number is desired. The Question Marks should be separated only by a letter space, not by a word space. Thus, to send "5NN 001, 5NN 002," and so forth, you send "5NN ??? during memory storage.

A contest number may only be imbedded in the memory location activated by key #1.

You can manually increment or decrement the number (in case you need to repeat or "catch up" to the correct contest number) by pushing the #3 key to increment, or the #4 key to decrement.

To reset an arbitrary contest number (in the middle of the contest, when you may have been using a different transceiver on a different band, for example), select Menu Item 7-3. Now rotate the Main Dial to select the next-to-be-used contest number, and press **ENT** to save your new number and exit.

To abbreviate certain numbers in the contest exchange, select Menu Item 7-6. In this Menu area, substitutions of Morse letters for (longer) numbers can be accomplished. For example, the keyer may be commanded to send "T" for "Zero," "A" for "One," "U" for "Two," and "N" for "Nine" while

leaving all other numbers in their normal (longer) formats. See the chart below for details of the selections available.

Contest Number "Cut" Format Menu Selection 7-6			
Number (Standard Morse)		Number (Cut Morse)	
0	-----	"T"	- **
1	.-----	"A"	..-
2	..-----	"U"	...-
3	...-----	"V"	....-
5	.....	"E"	.
7	-----	"B"	-...-
8	-----	"D"	---.
9	-----	"N"	-..
** The standard Morse zero (0) can alternately be sent as "O" (----)			+
4-Digit Contest Number Format			
Default	Truncated	Disabled	N/A
XXXX	XXX	OFF	N/A

To select between three-digit contest numbers (e.g. "599001") and four digit contest numbers (e.g. "5991234"), select Menu Item 7-6, then rotate the Sub Dial to the final selection, which is the number of playback digits. Select the desired number of digits, then press **ENT** to save the setting and exit. Note that, if you begin with a three-digit contest number, the FT-1000MP will automatically switch over to four-digit numbering after QSO #999.

### 2. CQ or ID Memory

The #2 key allows storage and recall of any message of up to 20 characters in length. Because of the convenient location of key #2 on the FH-1 Remote Control Keypad option, this memory location is most ideally suitable for your main "CQ TEST" message or for your callsign (for one-touch use in a pile-up, for example).

### 3. User Message Memories 1 - 4

Keys #5 ~ 8 allow storage and recall of messages of up to 50 characters in length. These memory locations are more suitable for longer messages which cannot be programmed into the "Contest Number" or "ID" memory locations.

### 4. Message Storage

The #9 key is used in the message memorization process. Push [ 9 ] followed by one of the

message playback keys ([ 1 ], [ 2 ], or [ 5 ] ~ [ 8 ]), then send (on your keyer paddle) the message to be stored, then press the [ 9 ] key to terminate the memory storage process.

### 5. Message Monitor (Playback without Transmitting)

The # 10 key may be used to review the contents of a memory location, or to determine the next-to-be-used contest number, without transmitting the message over the air.

To use this feature, the **MONI** key on the front panel of the transceiver must be turned off. The reason for this is that the **MONI** key activates the RF keying monitor, which requires a transmitted signal in order to function.

To check the contents of the "ID" memory slot, for example, press [ 10 ] then [ 2 ]. You will hear the message which currently is stored in the "ID" slot in the speaker or headphones. To check to see what the next-to-be-sent contest number is (in case you've forgotten, etc.), press [ 10 ] then [ 1 ]. The contents of the "#" memory slot will be played (e.g. "599388 BK"), and the contest number will not increment after playback in this mode; the contest number only increments if the message is sent over the air.

Remember, if pressing the #10 key, then a memory playback key, has no effect, you probably have the **MONI** button pushed in. De-activate the RF keying monitor to allow yourself to hear the stored message.

### 6. Tune Mode

Pressing the #12 key activates a transmitted carrier for as long as the key is held in; this is useful for adjustment of a linear amplifier or external antenna tuner, or for antenna performance comparisons over the air.

The power output level to be used for tuning is programmable via Menu Item 4-3. In this Menu selection, maximum power output levels of 10W, 50W, or 100W may be chosen. The front panel RF PWR control allows adjustment of the power level up to the maximum power output selected via Menu Item 4-3.

#### Contest Keyer Operation

Programming of the six available message storage locations is accomplished by a simple keyed and keyer paddle input sequence. Only lambic (not "Bug") keying can be used for storage of CW messages, and we recommend that Menu Item 7-0 be set to "lambic 2" during message

storage, although you may prefer to use "lambic 1" during manual sending once the desired messages are stored.

**Example:** Program "CQ TEST DX1DX DX1DX" into the "ID" Memory Slot.

- Be sure that the FH-1 (or your home-built) keypad is plugged into the rear panel **REMOTE** jack.
- Press key #9 ([**STO**]), followed by key #2 ([**ID**]). This selects the "ID" memory as the memory location to be utilized.
- Using your keyer paddle, send "CQ TEST DX1DX DX1DX" followed by another press of key #9 ([**STO**]) to end the storage process for this memory location. Be careful to pause slightly after each word so as to leave a word space in the message string.
- To play back the message memory without transmitting, press key #10 followed next by key #2. If you don't hear anything, check to be sure that the **MONI LED** on the bottom-left-hand edge of the FT-1000MP front panel is not illuminated.
- To transmit the CQ message, just press key #2. Message memories 1 ~ 4 (keys 5 ~ 8) are programmed, played back, and transmitted in the same manner; however, you can enter up to 50 characters in each of these. Particularly if you have a long callsign, you may wish to use key #2 for storage of just your callsign, then use message memories 1 ~ 4 (keys 5 ~ 8) for your "CQ Contest" messages.

Note also that if you want to send a message multiple times, you can press the playback key more than once; at the end of the first message segment, the message will restart and be sent again. This is useful if you want to call "CQ" while getting a drink from the refrigerator. You may then send a "K" manually when the automatic message generation is completed after the desired number of repeats.

**Example:** Program "599001 BK" as an initial contest number (to be incremented after each QSO):

- Following the procedure described above, press the #9 key ([**STO**]) then the #1 key ([**#**]).
- Now send the contest exchange, but send "???" at the point in the message where you want the number to appear. In this example, send "599??? BK" then press [**STO**] to terminate the entry. To send "5NN001 BK" modify your sending accordingly (the number-cutting protocol in Menu Item 7-6 only affects numbers sent within the "???" area). If you want to separate the signal report and the contest number, send "5NN ??? BK" (add a word space between the report and the question marks).



- To play back the just-stored message without transmitting, and without causing the contest number to increment automatically, press the #10 key followed by #1. You may do this as many times as you want and the contest number will stay the same. If you transmit the message by pressing the #1 key alone, however, the contest number will automatically increment, and another press of the #1 key will cause "599002 BK" to be sent (followed by "599003 BK" the following time, and so forth).
- If the other station asks for a repeat of your contest exchange, remember that the number will have incremented automatically after you sent it. Press the #4 key ([#DWN]) to return to the previous number, then press key #1 to repeat the exchange for the other station. If you need to increment the number manually for some reason, the #3 ([#UP]) key may be used in the same manner.
- If, for some reason, the contest number generated via key #1 is significantly different from the desired number, it may be reset via Menu Item 7-3. From this menu selection, you may set the next-to-be-used contest number to any value between 0000 and 9999 by rotating the Main Dial; press **ENT** to save the new setting and exit.

## II. VFO/Memory Control

Menu Item 7-9 also allows utilization of the Remote Control Keypad for VFO and Memory control. The front panel **VFO MEM**, **A-B**, **A=B**, **SPLIT**, **M-A**, **MCK**, **A-M**, **RCL**, **STO**, and **DUAL** keys, and **MEM CH UP/DWN** knob are duplicated on the Remote Control Keypad.

## III. Main VFO-A Control

Selection of this mode via Menu Item 7-9 duplicates the action of the 12-key front panel **BAND** keypad on the front panel of the FT-1000MP. Direct frequency entry and one-touch band change are possible on both the Main and Sub VFOs, exactly as on the front panel keypad.

## IV. Sub VFO-B Control

This function is essentially identical to "Main VFO-A Control" as described above. However, when the **ENT** key is pushed to begin direct frequency entry, the frequency input will be applied to the Sub VFO-B register, not the Main VFO-A register. This allows the operator to use the transceiver's front panel keypad for the Main VFO, and the remote keypad for the Sub VFO, thus reducing the required keystrokes by one.

Note that, in the Sub VFO-B Control mode, pushing **SUB CE** then **ENT** does not shift frequency entry control to the Main VFO-A (which is the "sub" VFO of Sub VFO-B). In this mode, frequency can only be applied to the Sub VFO-B; there is no direct frequency entry pathway to Main VFO-A.

Keypad Selections for Remote Control Features				
Remote Control Unit Key#	Remote Control Feature (menu selection 7-9)			
	Contest Memory Keyer	Memory Control Functions	MAIN VFO-A	SUB VFO-B
1	CQ Message	<b>VFO MEM</b>	1.8 1	1.8 1
2	Contest#	<b>A-B</b>	3.5 2	3.5 2
3	Increment Contest #	<b>A=B</b>	7 3	7 3
4	Decrement Contest #	<b>SPLIT</b>	10 4	10 4
5	MSG 0	<b>M-A</b>	14 5	14 5
6	MSG 1	<b>MCK</b>	18 6	18 6
7	MSG 2	<b>A-M</b>	21 7	21 7
8	MSG 3	<b>RCL</b>	24.5 8	24.5 8
9	Write Memory	<b>STO</b>	28 9	28 9
10	Playback (no Tx)	<b>DUAL</b>	29 0	29 0
11	N/A	<b>M CH UP</b>	<b>SUB CE</b>	<b>SUB CE</b>
12	Tune	<b>M CH DWN</b>	<b>ENT</b>	<b>ENT</b>

## User-Customized Operating Mode

### Overview

This mode recalls a pre-configured operating “environment” (mode, filter selections, offsets, etc.) by pressing the **USER** key.



This can be useful for storing your favorite combination of operational settings for a mode you often use. Digital operators who go through the various procedures of combining filter selections, carrier and display offsets, etc., for a custom environment optimized for FAX or SSTV (as an example) can store these settings for easy recall. For special modes that require unique configuration of transceiver settings that are not used elsewhere, the USER key comes in handy for storing these parameters while keeping other transceiver settings default for general operation.

The following parameters are user-customized by recalling menu selection 8-6. Operating parameters are chosen by turning the SUB VFO-B tuning knob, while parameter settings are changed with the MAIN VFO-A knob (see below).

Custom User-Mode Settings Menu Function 8-6		
Selected with:		
Sub VFO B Dial	Main VFO A Dial	Comments:
MODE	LSB, USB CW (USB) CW (LSB) RTTY (LSB) RTTY (USB) PACKET (LSB)	Select the operating situation to which the custom setting will be applied.
DISPLAY OFFSET	± 5.000 kHz	*see note below
RX PLL	± 5.000 kHz	*see note below
RX CARRIER	450 - 460 kHz	*see note belowM
TX PLL	± 5.000 kHz	*see note below
TX CARRIER	450 - 460 kHz	*see note below
RTTY OFFSET	± 5.000 kHz	*see note below
PRESET MODE	OFF SSTV FAX	Settings are factory preset & non-adjustable.
*the tables on pages 93-97 list various menu-selected receive and display offsets for each mode.		+

**Mode** - select from LSB, USB, CW (upper or lower), RTTY (upper or lower), or Packet (lower sideband only).

**Display Offset** - choose a custom offset ±5.000 kHz (in 5-Hz steps) to be displayed when the USER mode is active.

**Rx and Tx PLL Offset** - choose a custom PLL offset ±5.000 kHz (in 5-Hz steps) to take effect when the USER mode is active.

**Rx and Tx Carrier** - change the carrier injection frequency between 450-460 kHz.

**RTTY Custom Shift** - choose a custom (non-standard) RTTY shift of ±5.000 kHz (in 5-Hz steps) when the User mode is active.

**“Easy Setting”** - this allows choosing one of two *factory-configured* settings optimized for either SSTV (slow scan television) or FAX (facsimile) operation.

With the user settings customized as desired, pressing the **USER** key (its green LED glows when activated) recalls the user mode. The custom settings take effect and the display changes to reflect the new operating mode. To exit the User Mode, simply press any band, mode or function key so the green LED in the **USER** key turns off.

**Note:** see pages 93~97 for a complete listing of default settings according to operating mode.

### Important!

While the User-Mode allows customizing operation for various operating environments, changing some settings (especially the PLL offset and carrier injection) can adversely affect transceiver operation. Before making any User-Mode adjustments, ensure you have a firm understanding on how changing these affect transceiver operation and frequency display. If you are not sure, we recommend leaving them as set (to their default values shown in the table).

You can return *all transceiver settings* (menu selections) to their default values at any time by performing a CPU reset. Simply hold the **SUB CE**, **29 0** & **ENT** keys together while turning the transceiver on.

## Optional DVS-2 Digital Voice Recorder

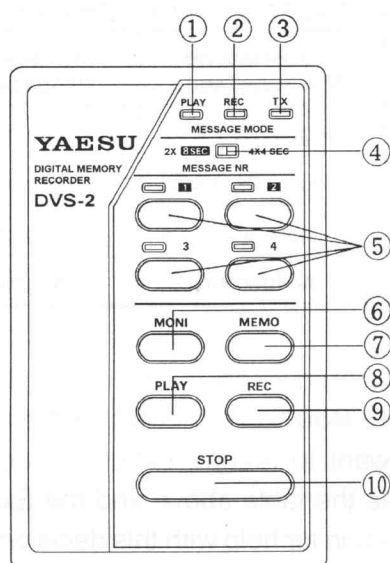

### Overview

The DVS-2 is a digital voice recorder designed especially for SSB, AM, and FM operation with newer model Yaesu transceivers having a special jack for connection of the DVS-2 on the rear panel. It offers two independent functions:

- recording received signals for playback later in the loudspeaker or headphone,
- recording signals by the microphone for playback over the air (during transmission).

Each mode uses its own memory, so both modes can be used to retain data at the same time. Operating details are provided with the DVS-2, but a summary is provided here.

### Installation

Connect the DVS-2 cable to the **DVS-2** jack on the rear of the transceiver. You must also have a microphone connected to the **MIC** jack on the front panel of the transceiver to record your voice for transmissions.



### DVS-2 Controls

#### (1), (2), & (3): PLAY, REC & TX LEDs

These LEDs light or flash to indicate the status of the DVS-2. The **PLAY** LED glows green when playing back stored data, the **REC** LED glows yellow when recording, and the **TX** LED glows red when the DVS-2 is keying the transmitter to play back over the air. Also, the **PLAY** and **REC** LEDs flash when waiting for you to make a memory selection (with a numbered button).

#### (4) MESSAGE MODE Slide Switch

This selects the mode for recording messages to be played back over the air: for either two 8-second messages, or four 4-second messages. Changing your selection does *not* erase previously stored messages, so you can use this switch to combine two pairs of 4-second messages.

#### (5) MESSAGE NR Selection Buttons & LEDs

These buttons select which message slot to record via the microphone or play back over the air. The LED above each button glows red when a message has been stored in that slot. The 3 and 4 keys (and LEDs) are only functional when the **MESSAGE MODE** switch is set to the **4 x 4 SEC** position.

#### (6) MONI Button

After recording a message via the microphone, press this button (followed by a message number button) to play back that message in the loudspeaker (instead of over the air).

#### (7) MEMO Button

Press this button (followed by a message number button) to record a message via the microphone.

#### (8) PLAY Button

After recording received signals, press this button to play them back in the transceiver's loudspeaker.

#### (9) REC Button

Press this button to start the receiver recorder. The recorder will run continuously (recording an 16-second loop) until you press the **STOP** button.

#### (10) STOP Button

Press this button to stop any recording or playback operation.

## Message Recording (from Main or Sub Receiver audio)

When used in this mode, the DVS-2 maintains a continuous recording of the last (approximately) 16 seconds of audio from either the main or sub-receiver. This can be particularly helpful in picking out callsigns during a pileup, as you can replay the same recording as often as you like (until you record over it). The record/playback process in this mode is analogous to an 16-second “endless tape” -that is, you can turn the recorder on and off to record up to a total of 16 seconds of small segments of audio, or you can leave the recorder running to get one 16-second segment. In any case, the recorder overwrites data more than 16 (recording) seconds old.

- To start the receiver recorder, just press the **REC** button. The yellow **REC** LED will light (and stay lit).
- When you hear something you want to play back, press the **STOP** button (the **REC** LED will turn off), and then press the **PLAY** button. Now the green **PLAY** LED will light as recorded audio is played back through the main receiver audio channel.

Note that if you record for less than 16 seconds, playback will start at the point you first started recording (no “rewind” necessary). However, if you record for more than 16 seconds, playback will begin at the point 16 seconds before you *stopped* recording. In either case, playback will repeat any recorded audio every 16 seconds.

- To stop the playback at any time, simply press **STOP**. If you then press **PLAY** again, playback will continue from the point you stopped it.

## Message Recording (from Microphone audio)

This mode allows the DVS-2 to record either two 8-second messages or four 4-second messages of audio from the microphone, such as contest exchanges or station IDs. Each can then be played back, either in monitor mode (without transmission), or directly over the air. Note that the digital memory used in this mode is independent from that used for receiver recording (so you can store both types of memory without interfering with one another).

The 8- and 4-second messages share the same memory, so two 4-second message segments (1 and 2 or 3 and 4) can be combined into one 8-second message for transmission, as indicated in the following table.

Memory Segments & Message Numbers

Button Pressed	Segment(s) Used in Record/Playback	
	2 x 8-second Message Mode	4 x 4-second Message Mode
1	Segments 1 & 2	Segment 1
2	Segments 3 & 4	Segment 2
3	no function	Segment 3
4	no function	Segment 4

Before you record for transmission, check that the **MESSAGE MODE** switch is set for the size message you want to record, either 4-second or 8-second (see the table above and the Example in the next section for help with this decision). You do not need to press the **PTT** switch while recording a message, although you can, in which case your audio will be transmitted and recorded simultaneously.

- Get your microphone ready, and then press the **MEMO** button (the yellow **REC** LED will blink).
- Now press the numbered key for the segment (or segment pair) to record (only 1 or 2 for the 8-second mode), and start talking (do not press the **PTT** switch unless you want to transmit at the same time you are recording).

The **REC** LED will stop blinking and stay on for the recording period (4 or 8 seconds), and then turn off. Also, the red **LED** above the numbered key you pressed will come on (if this segment was previously empty) and stay on, indicating this segment is now storing data.

- To stop recording at any point *before* the selected segment’s time limit is up, simply press **STOP**.

This is the preferred method, since it eliminates any “dead time” remaining from your last-recorded word and end of the time segment (which would keep your transmitter unnecessarily keyed for a short period). In any case, your message can not exceed the 4- or 8- second limit.

Don’t worry if you didn’t have enough time to finish your phrase, you can repeat the above steps to re-record the same message - the previous message will be overwritten. (Note that there is no “rewind” step required).

## Message Monitor (Playback Without Transmitting)

You can check the contents of a memory segment or pair without playing it back over the air, just by pressing **MONI** followed by the appropriate numbered key. The green **REC** LED blinks until you press the numbered key, and then stays on during the playback period. We recommend always using this to check the results immediately after making a recording and before playing it back over the air. If you have recorded several 4-second segments that you intend to combine during playback, move the **MESSAGE MODE** switch to the **2 x 8 SEC** position to hear how the segments sound when played back together. Note from the table on the preceding page that, in the 8-second mode, the 1 button plays back segments 1 and 2, while the 2 button plays back segments 3 and 4.

## Message Transmission (“On The Air” Playback)

After recording a memory segment, you can play it back over the air by pressing the appropriate numbered button. The green **PLAY** and red **TX** LEDs will both light for a maximum of either four or eight seconds, according to the setting of the **MESSAGE MODE** switch.

### Receiver Recording with the FT-1000MP

As the DVS-2 uses only one receiver audio channel of the FT-1000MP, you can play back recordings without missing real-time action by pressing **[A-B]** to set the two VFOs to the same frequency.

With stereo headphones, this allows you to continually monitor signals on the sub VFO audio channel while playing back recording on the main channel.

**Note!** Normally, pressing a numbered message key on the DVS-2 activates the FT-1000MP transmitter and sends the recorded message. If you would like to disable PTT control from the DVS-2, recall menu selection 4-7 and change the setting to OFF. Now, transmission is only possible using the microphone PTT or **MOX** switches.

Since you will probably want to take advantage of combining messages for playback, you may want to take a few minutes to plan out your segment recording strategy. Consider the following example:

Example Using the 4 segment-by-4-second mode, if you stored the segments like this:

Segment 1: CQ Contest CQ Contest  
CQ Contest from [your call]

Segment 2: [your callsign]

Segment 3: QSL, you're 5-9, 200 (contest #)

Segment 4: QRZ contest from [your call]

In the contest, you would then,

- Switch to the 2-segment-by-8-second mode to combine the segment pairs,
- Press button 1 to send segments 1 & 2 (“CQ Contest CQ Contest CQ Contest from [your callsign]”) until you got a response,
- Send the other station’s callsign,
- Press button 2, to send segments 3 & 4 (“QSL, your 5-9, 200...QRZ Contest from [your callsign]”).

Notice in this example, you can operate the entire contest while only having to send the other station’s callsign by voice - all repetitive information is handled by the DVS-2 (of course, in contests where you need to include a QSO count, you would want to arrange the segments a little differently, perhaps using the 4-by-4-second mode for transmissions).

### Selecting Receiver Audio

As mentioned earlier, the DVS-2 can record audio from either the Main or Sub receiver. To choose the desired receiver, recall memory selection 4-6 and pick either MAIN VFO or SUB VFO as the default receiver.

# Linear Amplifier Operation & Interconnections

The FT-1000MP can be used with the optional Yaesu FL-7000/VL-1000 which provides automatic band switching via digital band data output from the **BAND DATA** jack on the rear panel of the transceiver. Most other amplifiers can be adapted to operate with the FT-1000MP; however, the main points to be concerned with are the switching requirements of the amplifier, and if QSK (full break-in) operation is desired. The linear amplifier Tx/Rx switching capability of the FT-1000MP is described in the table below.

Parameter	Operation	
	QSK Relay Disabled	Non-QSK Relay Enabled
DC Switching Voltage	< 15 VDC	< 220 VDC
DC Switching Current	< 100 mA	< 300 mA
AC Switching Voltage	-	< 125 VAC
AC Switching Current	-	< 200 mA

## Operation with QSK Amplifiers

Connect the RF output from the transceiver ANT jack (A or B) to the RF input jack of the linear. Connect the ALC output from the linear to the **EXT ALC** jack on the rear of the transceiver. After making the RF and Tx/Rx switching connections described below, you may need to adjust the ALC output level of the linear so that it is not overdriven by the FT-1000MP. Your linear's manual should describe how to do this.

If using an FL-7000, connect optional cable E-767 (P/N D4000019) from the transceiver **BAND DATA** jack to the amplifier **ACC-2** jack. This provides automatic band selection for the linear, as well as QSK Tx/Rx switching control. If using another manufacturer's QSK linear, and if it can be switched with less than 100 mA of DC voltage below 15 V, you can connect the Tx/Rx switching line for the linear to pin 2 of the **BAND DATA** jack, and the linear's exciter-enable output to pin 8 of the **BAND DATA** jack. This line must be held to ground to enable transmission after the linear is ready for excitation from the FT-1000MP. If your QSK linear requires more than 100 mA or uses more than 15 V for T/R relay switching, you will have to provide a suitable external interface transistor, controlled by pin 2.

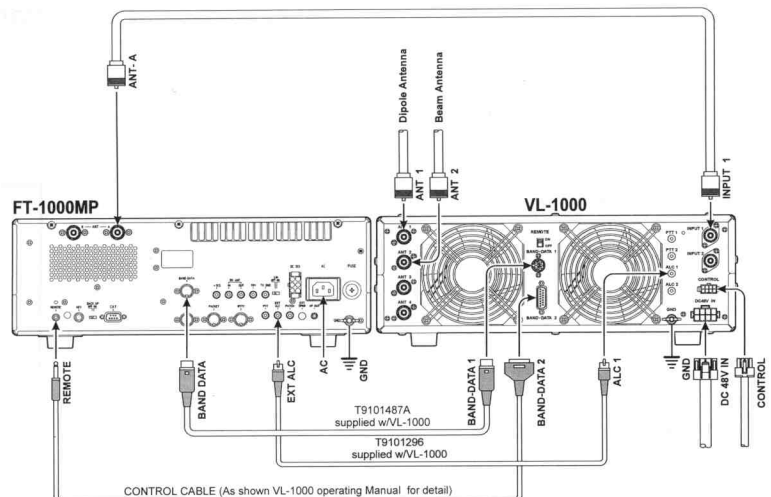
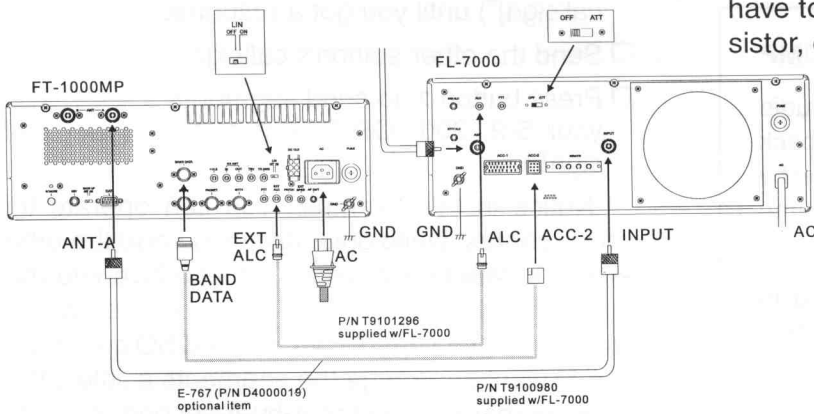

### Operation with non-QSK Amplifiers (FL-2100 series or others)

The TX GND jack on the transceiver rear panel is connected to an internal relay, for non-QSK T/R switching of linear amplifiers that use AC voltage, or DC voltage greater than -15 V, or require more than 100 mA for T/R switching. A schematic diagram of the relay circuit is provided below.

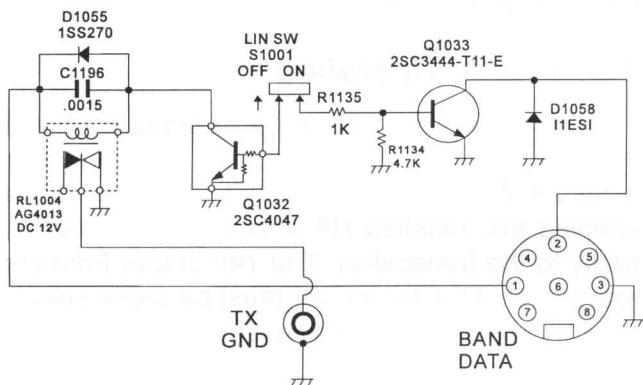

This relay comes disabled (LIN switch S1001 set to OFF) to avoid the clicking sound when the transceiver is used alone or with a QSK linear. To enable the relay for non-QSK linears that exceed the above T/R switching requirements, you will need move LIN switch S2001, located in the hole near the center of the rear panel, to its right position (see the drawing). Use a thin, insulated, sharp object to move the switch. Then connect the center contact of the TX GND jack to the positive line to your linear, and the outer contact to the

negative line or the linear's chassis ground (if there is no separate negative line). Refer to the diagram at the page bottom, in this example, a older non-QSK amplifier (FL-2100B) is shown.

With the relay now enabled, the FT-1000MP can support non-QSK linear T/R switching voltages up to 125 VAC @ 200 mA, or DC voltage up to 220 V @ 300 mA, or closed-circuit current up to 2 A with DC voltage up to 30 V.

#### Caution - Please Read!!

The FT-1000MP is designed for use with the FL-7000/VL-1000 when QSK operation with a linear amplifier is desired. If you are using a different amplifier *do not attempt QSK operation with the linear if its switching requires the relay enabled*. Using pins 2 and 8 of the BAND DATA jack for other amplifiers will not work unless the control line signals are carefully matched, and damage may result otherwise.

Your warranty does not cover damage resulting from improper connections to this jack, so if you are not sure of the linear amplifier's break-in capabilities or switching requirements, the safest approach is to enable the relay, use the TX GND jack (after setting S1001 to the ON position) and resort to non-QSK operation. This will help prevent possible damage to the amplifier or transceiver.

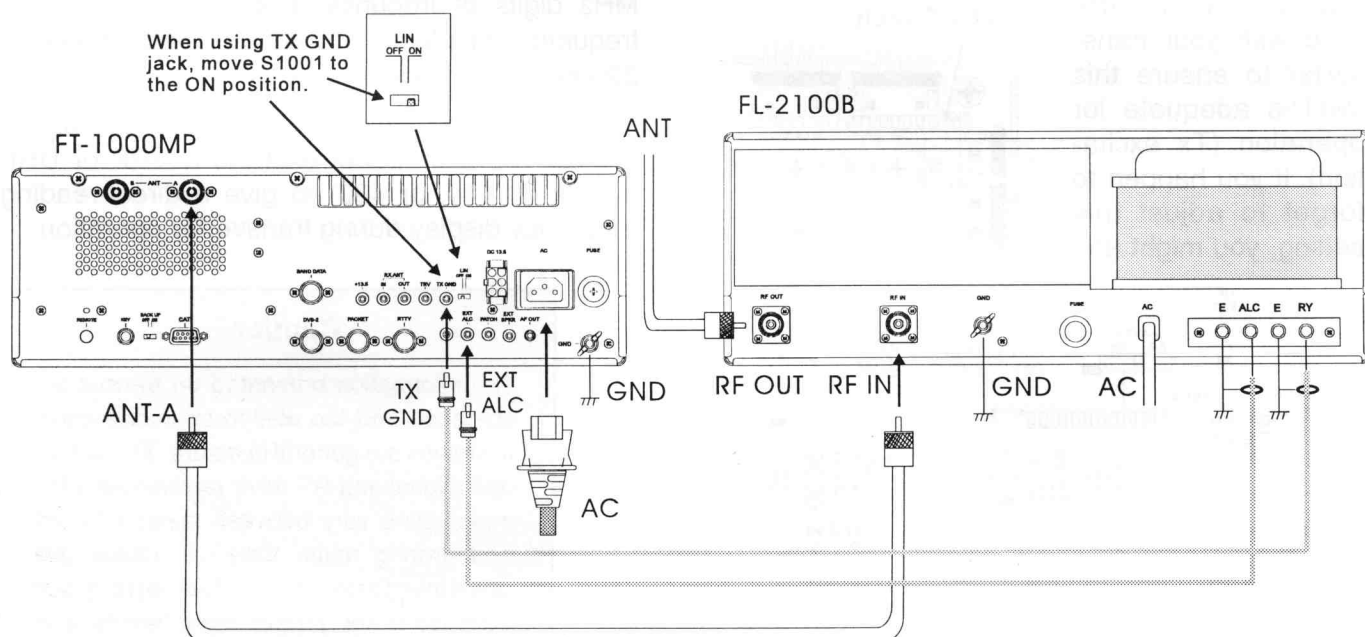

## Transverter Operation

Although Yaesu Musen does not presently manufacture transverter units, the FT-1000MP can be used with some transverter units from other manufacturers, or older Yaesu units, such as the FTV-107R and FTV-707.

### Transverter Operation Overview

Transverters allow operating your HF transceiver on VHF and UHF bands. Many commercially available transverters provide coverage of the 50, 144, and/or 430 MHz amateur bands. During receive, the VHF or UHF input passband is amplified, filtered, and mixed with a local signal to provide a “down-converted” output falling within the receive range of the FT-1000MP (usually 28 ~ 30 MHz). Likewise, a *low-level* 28 ~ 30 MHz transmitted signal is sent to the transverter where it is again mixed with a local signal, band-pass filtered, and amplified several stages to provide a “up-converted” VHF or UHF signal output.

The TRV jack on the rear panel of the transceiver provides a *variable* low-level (approximately -6 dBm, 100 mV<sub>RMS</sub> @ 50 Ω) RF signal output used to drive the transverter circuitry. This low-level output should be connected to the transverter RF IN jack (or equivalent).

Slide the TRV switch on the ALC Unit to the “TRV” position to disable the HF power amplifier. Use the front panel RF PWR control to adjust the low-level drive level applied to the transceiver’s RF input jack (-6dBm maximum). Check with the documentation supplied with your transverter to ensure this level is adequate for operation (Tx excitation). If you happen to forget to adjust this setting, you might end

up transmitting full HF power output while also exciting your transverter.

**Note** - The switching circuitry of many transverters is not designed to handle the high power output direct from the amplifier section of a transceiver. Do not connect your transverter directly to the FT-1000MP’s ANT jack.

### Transverter Operation

A transverter station setup example is shown below. It utilizes the RX ANT IN jack for connection of the 28 MHz RX (converted) signal, which allows keeping the installed HF antenna connected directly to the transceiver. The TRV output from the rear panel of the transceiver must be connected to the RF IN jack of the transverter.

- During transverter operation, *remember to move the TRV switch on the ALC Unit to the “TRV” position*, and adjust the RF PWR control fully clockwise (unless a lower drive level is needed).
- Press the RX ANT switch to receive the “transverted” (downconverted) VHF input. Press 28 9 to select 28 MHz for operation, and refer to the documentation provide with your transverter for tune-up and operation.

### Transverted Frequency Display

Most transveter outputs usually fall somewhere within the 10-meter band (28~30 MHz), which requires mentally “substituting” the actual MHz digits of frequency digits of the operating frequency in place of the displayed 28.xxx or 29.xxx panel frequency.

You can use menu selection 3-3 to temporarily change the MHz panel digits to a VHF or UHF band (50, 144, or 430) to give a direct-reading frequency display during transverter operation.

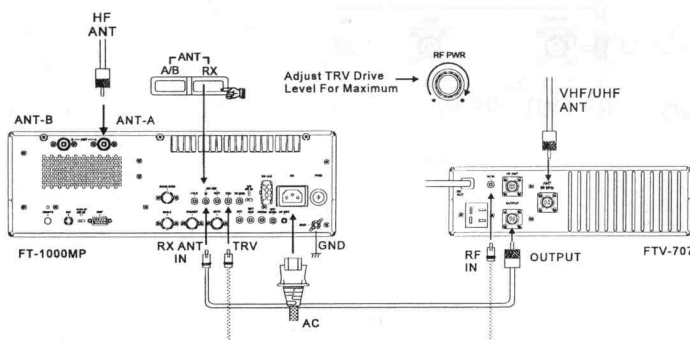
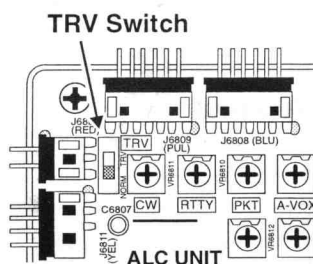

Example of Transverter Station Interconnections

### Caution!

The information presented on transverter operation and the station interconnection examples are general in nature. The actual operational and RF drive requirements for transverters vary between manufacturers and among units. Carefully check the documentation provided with your transverter for proper input levels and station interconnections.



# Phone Patch Operation

## Overview

Phone patch operation allows linking your FT-1000MP to the public telephone line to provide two-way simplex communications for MARS operation, or on behalf of a third parties. The FT-1000MP may be used with the LL-7 phone patch unit installed in the optional SP-8 external loudspeaker, or with phone patch units from other manufacturers. The diagram at the bottom of the page shows interconnection for the SP-8/LL-7 combination; be sure to consult the documentation provided with units of other manufacture for installation instructions.

## Operation

Phone patch Tx/Rx switching may be done manually using the PTT method, or automatically using the VOX circuit of the transceiver. While the PTT method does not require balancing the bridge circuit in the LL-7, it does require more work by the operator: switching the microphone PTT or transceiver **MOX** button at each "over" during patched conversations. Therefore, most operators prefer to use the VOX method whenever the telephone signal-to-noise level permits. If the telephone noise level is high, however, the PTT method may still be necessary, so you should become familiar with both methods.

**Note**

You may need to contact your telephone company for permission to connect another device to the phone circuit. Also, you should use a proper 600-Ω, three-way transformer if connecting the LL-7 with a telephone set to the same phone line.

Regardless of which patch control method is used, you may need to instruct the person on the telephone to speak slowly at a clear normal voice, and to say "over" and then keep quiet when they expect a response from the other radio station. This serves as a notice to you (if you are using PTT control) to switch to receive while signaling the other station to go ahead and transmit, and will help avoid "doubling" with the other station.

During all phone patch operation you should monitor both sides of the conversation at all times (this may be required by law). This requires a telephone at the operating position.

*Refer to the LL-7 Instruction Sheet for further details on phone patch setup and operation.*

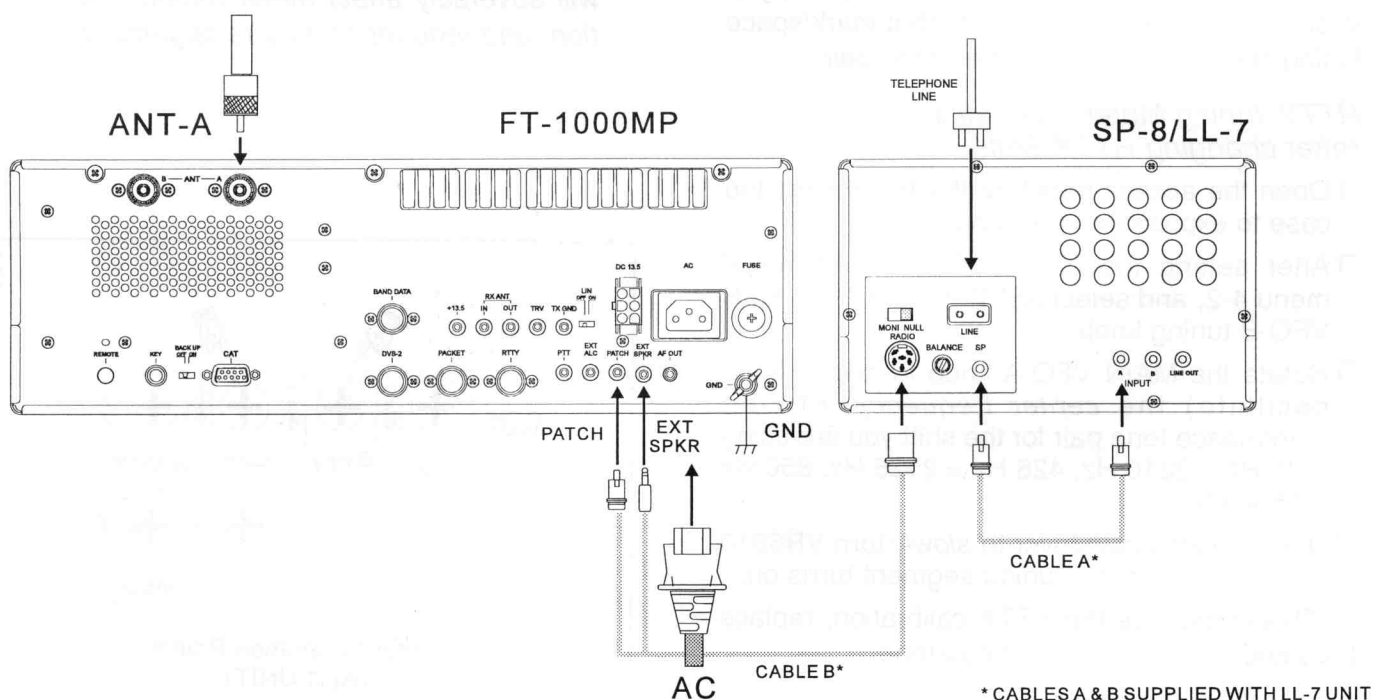

## Addendum - Tuning Meter Re-Calibration

The multi-function meter offers either flashing single or dual segments to indicate properly tuned CW or FSK (RTTY/PKT) stations. An explanation of tuning indications is on page 28.

### CW Tuning

From the factory, the single CW tuning segment is calibrated (centered) *for the default CW Pitch setting of 700 Hz*. If you change the CW Pitch (page 39~40) to other than 700 Hz, you should re-calibrate the meter so that station center-tuning will match the new CW Pitch. Calibration is a simple process, and only requires a small phillips screwdriver:

#### CW Tuning Meter Calibration (after CW Pitch adjustment)

- Open the access panel on the transceiver top case to expose the ALC Unit.
- After setting the desired CW Pitch, press the **SPOT** button to toggle the CW spot tone (which matches the CW Pitch) on.
- Use a small screwdriver to *slowly* turn **VR6811** so the center meter tuning segment turns on.

This completes the calibration for CW tuning, replace the panel, and turn off the spot tone.

### RTTY Tuning

RTTY tuning segments are calibrated (centered) *for default 170-Hz shift*, using a mark/space pair of 2125/2295 Hz. If you change the default RTTY shift (menu 6-0) to other than 170 Hz, you should re-calibrate the meter so that mark/space tuning segments match the new tone pair:

#### RTTY Tuning Meter Calibration (after changing RTTY Shift)

- Open the access panel on the transceiver top case to expose the ALC Unit.
- After setting the desired RTTY shift, recall menu 4-2, and select bEEP-tun using the SUB VFO-B tuning knob.
- Rotate the MAIN VFO-A knob to display (and oscillate) the *center frequency* of the mark/space tone pair for the shift you are using (170 Hz = 2210 Hz, 425 Hz = 2125 Hz, 850 Hz = 2550 Hz).
- Use a small screwdriver to *slowly* turn **VR6810** so the center meter tuning segment turns on.

This completes the RTTY calibration, replace the panel, and turn off the beep tone.

### Packet Tuning

The dual packet tuning segments are calibrated (centered) *to the default 200-Hz shift tones* used for 300-baud HF packet. These tones use a mark/space pair of 2025/2225 Hz. If you change the default PKT tones (menu 6-5) to other than 2025/2225 Hz, you should re-calibrate the meter so that mark/space tuning segments will match the new tone pair:

#### PKT Tuning Meter Calibration (after changing PKT Tones)

- Open the access panel on the transceiver top case to expose the ALC Unit.
- After selecting the desired tone pair, recall menu 4-2, and select bEEP-tun using the SUB VFO-B knob.
- Rotate the MAIN VFO-A knob to display (and oscillate) the *center frequency* of the mark/space tone pair you are using (1170 Hz, 1700 Hz, 2125 Hz, 2210 Hz - see page 55).
- Use a small screwdriver to *slowly* turn **VR6809** so the center meter tuning segment turns on.

This completes the PKT calibration, replace the panel, and turn off the beep tone.

### Caution!

*Do not adjust VR6812 by mistake, as this will adversely affect meter tuning indication, and requires factory re-alignment!*

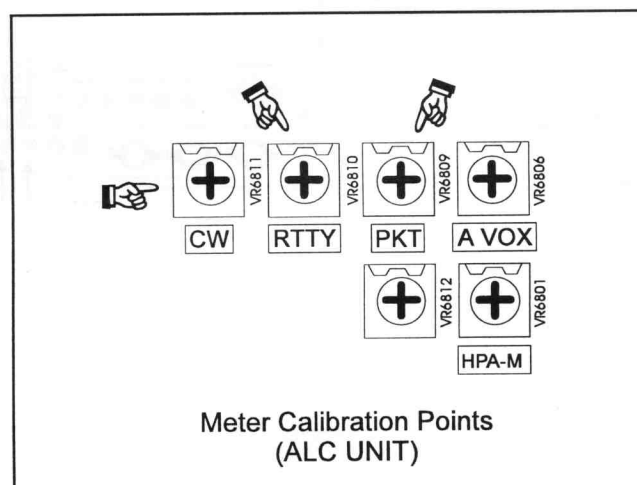

## Cat System Computer Control

### Overview

The CAT (Computer Aided Transceiver) System in the FT-1000MP provides control of frequency, VFO, memory, and other settings such as dual-channel memories and diversity reception using an external personal computer. This allows multiple control operations to be fully automated as single mouse clicks or keystroke operations on the computer keyboard.

The FT-1000MP has a built-in level converter, allowing direct connection from the rear-panel CAT jack to the serial port of your computer without the need of any external boxes.

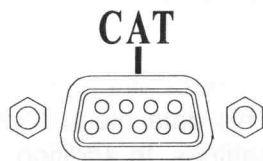

Each time a command instruction is being received from the computer via the CAT port, the **CAT** indicator appears in the display, then turns off afterward. You will need a serial cable for connection to the RS-232C (serial or COM port) connector on your computer. Purchase a standard serial cable (not the so-called "null modem" type), ensuring it has the correct gender and number of pins (some serial COM port connectors use a 9-pin rather than 25-pin configuration). If your computer uses a custom connector, you may have to construct the cable. In this case, refer to the technical documentation supplied with your computer for correct data connection.

Yaesu Musen does not produce CAT System operating software due to the wide variety of personal computers and operating systems in use today. However, the information provided in this chapter explains the serial data structure and opcodes used by the CAT system. This information, along with the short programming examples, is intended to help you start writing programs on your own. As you become more familiar with CAT operation, you can customize programs later on for your operating needs and discover the true operating potential of this system.

There are some commercially produced software packages available, as well as various shareware and freeware programs. To find out more information, contact your dealer or check advertisements in current amateur radio journals and publications. Other valuable information

sources include amateur radio and PC users-groups, packet radio and PC bulletin boards (BBS), and amateur radio hamfests.

### CAT Data Protocol

Serial data is passed via the CAT jack on the rear panel of the transceiver at 4800 bits/sec. All commands sent from the computer to the transceiver consist of *five-byte blocks*, with up to 200 ms between each byte. The *last* byte sent in each block is the *instruction opcode*, while the first four bytes of each block are arguments: either parameters for that instruction, or dummy values (required to pad the block out to five bytes):

Byte 1	Byte 2	Byte 3	Byte 4	Byte 5
Argument	Argument	Argument	Argument	Instruction OPCODE
<b>CAT 5-BYTE COMMAND STRUCTURE</b>				

Each byte sent consists of one start bit, 8 data bits, no parity bit and two stop bits:

Start Bit	0	1	2	3	4	5	6	7	Stop Bit	Stop Bit
<b>CAT DATA BYTE FORMAT</b>										

There are twenty-nine instruction opcodes for the FT-1000MP, listed in the table on pages 80-83. Most of these duplicate menu programming settings or options, or else emulate front panel button functions. Notice that several instructions require no specific parameters. However, every Command Block sent to the transceiver *must* always consist of five bytes.

The CAT control program you are writing must construct the 5-byte block, by selecting the appropriate instruction opcode, organizing the parameters, if any, and providing unused (dummy) argument bytes for padding the block to its required 5-byte length (the dummy bytes can contain any value). The resulting five bytes are then sent, *opcode last*, from the computer to the FT-1000MP CPU via the serial port and CAT jack on the transceiver rear panel.

## Constructing and Sending CAT Commands

**Example #1:** Set Main VFO-A to 14.25000 MHz;

- First determine the opcode for the desired instruction by referring to the CAT Commands Table. A good idea would be to store these opcodes within the program, so they can be looked up when the user requests the corresponding command.
- Here the instruction is "Set Main VFO Frequency", so the opcode (last byte of the block) is 0AH. Note - "H"s following each byte value indicate hexadecimal (base 16) values.
- Build the four argument byte values from the desired frequency by breaking it into 2-digit blocks (BCD "packed decimal" format). Note that *a leading zero is always required in the hundreds-of-MHz place* (and another in the tens-of-MHz if below 10 MHz).
- Breaking 14.250.00 MHz into its BCD component, we arrive at:

10's Hz	100's Hz	1's KHz	10's kHz	100's kHz	1's MHz	10's MHz	100's MHz
0	0	0	5	2	4	1	0
00		50		42		01	
Byte 1		Byte 2		Byte 3		Byte 4	

- Inserting the 4-byte BCD-coded frequency (00, 50, 42, 01), the resulting 5-byte block should now look like this (again, in hex format):

Byte 1	Byte 2	Byte 3	Byte 4	Byte 5
00	50	42	01	0AH
DATA / ARGUMENT BYTES				OPCODE

- Send these five bytes to the transceiver, in the order shown in the table above — from left-to-right: **00 50 42 01 0AH**

**Example #2:** Activate a RX Clarifier Offset of +3.5 kHz.

- Clarifier settings are controlled from opcode 09H. The first four parameter bytes determine the type of offset, direction, and frequency displacement.
- According to the example, the first byte would be **50** (500 Hz), the second **03** (3000Hz), followed by **00H** (for +offset), **81H** (TX CLAR on) and then opcode **09H**. Remember that the 1st and 2nd bytes are in BCD format.

- Completing the command byte sequence, we would send, in sequence, 50H, 03H, 00H, 81H, 09H, to effect the Tx clarifier offset.

Byte 1	Byte 2	Byte 3	Byte 4	Byte 5
50H	03H	00H	81H	09H
DATA/ARGUMENT BYTES				OPCODE

You should be getting a feel for the CAT command structuring sequence, let's move to the next step; reading transceiver operational data.

## Downloading FT-1000MP Data

On command, the FT-1000MP will download some or all (1,863 bytes) of its operational data. This data block contains all current transceiver settings. In addition, the current meter indication (Tx or Rx) is read, digitized and returned as well. This provides a wealth of information in near real-time that can be processed by your program or the running application for control purposes or display readouts. By regular or intermittent requests for this data, the program (and you) can be kept continuously up-to-date on the status of the FT-1000MP operating environment.

The following four commands cause the FT-1000MP to download various operational and internally stored settings via the CAT port:

**Status Update (10H)** - causes the transceiver to return all or portions of its RAM table (up to 1,863 bytes).

**Status Flags Request (FAH)** - obtains only the first 6 bytes (the Status Flags), plus 2 extra "Model ID" bytes (10H and 00H).

**Read Meter (F7H)** - returns the meter deflection (0 — FFH) repeated in four bytes, followed by one "filler" byte (F7H).

**Pacing Command (0EH)** - Each byte of returned data may be delayed by an interval determined by this command (0 to 255 ms in 1-ms steps). This delay is initially zero until the Pacing command is sent (see note below).

**Note:** Pacing allows returned data to be read and processed by slower computers. However, set it as short as your computer will allow, to minimize the inconvenience of the delay. Sending all 1,863 bytes requires just under 5 seconds with zero-length delay selected, but over 5 minutes if the maximum delay is selected!

### 1863-Byte Status Update Data (Sent L-to-R)

Status Flags	Memory Channel No.	Operating Data	VFO-A Data	VFO-B Data	Memory Data
6	1	16 bytes	16 bytes	16 bytes	16-bytes (x 113 memories=1808 bytes total)
(A)	(B)	(C)	(D)	(E)	(F)

#### Status Update Data Organization

An overview of the Status Update Data that can be returned to the PC in response to one of the Status Update requests (opcodes 10H, FAH, F7H, or 0EH) is shown above. The 1,863-byte block begins with six bytes, each containing one-bit state Status Flags (A), for a total of 48 bits, followed by one byte indicating the current (or last selected) Memory Channel (B), followed by 116 x16-byte data records: one for the current Operating Data (C), one each for VFO-A (D) and VFO-B (E), and one for each of the 113 memories (F).

Of the four commands that cause Status Update to be returned, remember that only opcode 10H (with its last argument set to zero) returns all of the data (see bottom right of this page).

#### STATUS FLAGS (BYTES 1~ 6)

Each of the first six bytes are subdivided into 1-bit flag fields: if a bit is set (1), the function is enabled (on); and if reset (0), the function is disabled (off). These flags reflect the current states of various transceiver functions, most of which appear in the radio display as indicators or LEDs. The Status Flags command returns these bytes for use in the control program (you could replicate these indicators on the computer display, or else use them as control flags for routines, etc.). Bit offsets for all six bytes is shown on page 76.

#### MEMORY CHANNEL DATA (BYTE 7)

The seventh Update Data Byte contains a binary value from 00~70H, corresponding to the current memory channel number on the display. Only this byte is returned by sending the Status Update command with the first parameter set to 1. The chart on page 77 lists the corresponding hexadecimal codes for memory channels 01~99, P1~P9, and QMB memories 1~5.

#### 16-BYTE DATA RECORDS (BYTES 8~1863)

The remainder of the operational data returned by the Status Update command consist of 16-byte data records, indicating VFO and memory-specific selections. The first of these records is for the current display, followed by the VFO-A, VFO-B, and then the 113 memory channels, from lowest to highest. Please review the table at the top right column on page 77, which outlines the structure of a 16-byte data record. Each byte is identified by its offset from the start (base address) of the record. A further breakdown of each byte offset is also provided.

Note that this same 16-byte data record format is used for the VFO and Memory Data as well, unless you are currently operating on a retuned memory (M TUNE displayed).

#### Selecting Update Data to Download

As mentioned before, there are four opcodes that cause the FT-1000MP to report (update) its operating status by downloading all or a portion of its 1,863 data bytes. These opcodes are shaded in the CAT Commands table (pages 80~83).

**Status Update** (Opcode 10H) - The 1st and 4th parameters of this command allow selecting different portions of Status data to be returned, as follows ("X" is the 1st parameter, "U" is the 4th):

Parameter	Bytes Returned	Data Returned	Comments
U = 00H	1, 863	All Status Update Data	See the box on page 74-Pacing Command
U = 01H	1	Memory Channel No.	Current, or Last-Selected Memory
U = 02H	16	Current Operating Data (VFO or Mem)	See the Tables on pages 77~78 for 16-byte data record structures.
U = 03H	32 (2 x 16)	Main VFO-A & Sub VFO-B Data	
U = 04H*	16	Memory Data	
X = 00~71H	N/A	X = Memory (1~99, P1~5, Q1~5) *only used when U = 04H	

## CAT System Computer Control

**Read Flags** (Opcode FAH) - This command can be set to retrieve all six Status Flag bytes, or else five bytes - three Status Flag Bytes, plus two *transceiver ID* bytes. The Status Flag Bytes are described on the preceding page, and in the Record Tables below.

The transceiver ID bytes are used in programs to distinguish the FT-1000MP from other models, which have different, unique values returned in this situation. The constant values of 03H and 93H are returned by the FT-1000MP (and only the FT-1000MP), as shown:

Flag Byte 1	Flag Byte 2	Flag Byte 3	ID Byte 1 (03H)	ID Byte 2 (93H)
-------------	-------------	-------------	-----------------	-----------------

**Read Meter Data** (Opcode F7H) - Sending this command returns a digitized meter deflection indication, between 0 and FFH (usually around F0H maximum). Four copies of this value are returned, along with one padding byte (0F7H), as follows:

Meter Byte	Meter Byte	Meter Byte	Meter Byte	F7H
------------	------------	------------	------------	-----

During reception, the signal strength deflection is returned. During transmission, the parameter represented by the reading returned depends on the setting of the **METER** switch.

### 6-Byte Status Flags Record Table

Bit Offset	STATUS FLAG BYTE #1 CONTENTS
0	Split Frequency operation
1	Dual Receive operation
2	Antenna Tuning In Progress
3	CAT System Activated
4	SUB VFO-B In-Use (Rx/Tx LED On)
5	Keypad Entry In Progress
6	Main Receiver Muted
7	PTT Keyed (Tx Active)

Bit Offset	STATUS FLAG BYTE #4 CONTENTS
0	2nd IF 455 kHz Filter Selection Active
1	1st IF 8.2 MHz Filter Selection Active
2	N/A
3	N/A
4	PTT Keyed via CAT Command
5	General Coverage TX Inhibit
6	Key Release Timer Active
7	Tx Inhibit

Bit Offset	STATUS FLAG BYTE #2 CONTENTS
0	5-sec. MEM CHK Timer Active
1	Memory Checking In-Progress
2	Dual VFO Tracking Active
3	Quick Memory Bank Selected
4	Memory Tuning Active
5	VFO Operation
6	Memory Operation
7	General Coverage Reception

Bit Offset	STATUS FLAG BYTE #5 CONTENTS
0	RTTY Tx Idle
1	N/A
2	N/A
3	Grouped Memory Mode Active
4	ANT B Selected
5	RX ANT Selected
6	PMS Tuning Active
7	AM Synchronous Mode Active

Bit Offset	STATUS FLAG BYTE #3 CONTENTS
0	FAST Tuning Active
1	Antenna Tuner (ATU) In-Line
2	SUB VFO-B Locked
3	MAIN VFO-A Locked
4	Squelch Closed
5	Scan Direction (Up/Dwn)
6	Scanning Paused
7	Auto Memory Write Scanning Active

Bit Offset	STATUS FLAG BYTE #6 CONTENTS
0	Sub Receiver Audio Muted
1	Main Receiver Audio Muted
2	Dual VFO Tracking
3	N/A
4	N/A
5	VFO Channel Stepping
6	Tuner Wait (while tuning)
7	High SWR Detected

### 1-Byte Memory Channel Number Data Structure

This identifies the current or last-selected memory channel 1~99, P1~P5 or QMB 1~5 for operation. The table below translates hexadecimal codes into corresponding memory channel numbers. Please read the note in the box at the page bottom.

Memory Channel Data (Hex Codes)							
Ch.	Hex	Ch.	Hex	Ch.	Hex	Ch.	Hex
01	00H	30	1DH	59	3AH	88	57H
02	01H	31	1EH	60	3BH	89	58H
03	02H	32	1FH	61	3CH	90	59H
04	03H	33	20H	62	3DH	91	5AH
05	04H	34	21H	63	3EH	92	5BH
06	05H	35	22H	64	3FH	93	5CH
07	06H	36	23H	65	40H	94	5DH
08	07H	37	24H	66	41H	95	5EH
09	08H	38	25H	67	42H	96	5FH
10	09H	39	26H	68	43H	97	60H
11	0AH	40	27H	69	44H	98	61H
12	0BH	41	28H	70	45H	99	62H
13	0CH	42	29H	71	46H	P1	63H
14	0DH	43	2AH	72	47H	P2	64H
15	0EH	44	2BH	73	48H	P3	65H
16	0FH	45	2CH	74	49H	P4	66H
17	10H	46	2DH	75	4AH	P5	67H
18	11H	47	2EH	76	4BH	P6	68H
19	12H	48	2FH	77	4CH	P7	69H
20	13H	49	30H	78	4DH	P8	6AH
21	14H	50	31H	79	4EH	P9	6BH
22	15H	51	32H	80	4FH	Q1	6CH
23	16H	52	33H	81	50H	Q2	6DH
24	17H	53	34H	82	51H	Q3	6EH
25	18H	54	35H	83	52H	Q4	6FH
26	19H	55	36H	84	53H	Q5	70H
27	1AH	56	37H	85	54H		
28	1BH	57	38H	86	55H		
29	1CH	58	39H	87	56H		

### 16-Byte Data Record Structure

The following tables outline the 16-byte data record structure common to the Operating Data, VFO-A, VFO-B and Memory Data records. The table below shows assignments for each of the 16-bytes in the Operating Data Record.

Byte	16-Byte Data Record Assignment
0	Band Selection
1	Operating Frequency
2	
3	
4	
5	Clarifier Offset
6	
7	Operating Mode
8	IF Filter Selection
9	VFO/MEM Operating Flags
A~F	Not Used

**Band Selection** - The 0.1~30 MHz transceiver operating range is divided into 28 bands, represented in hexadecimal format in the table below. Data read in this record after downloading is in binary format, and must be converted to hexadecimal, then translated to the corresponding band.

Hex Code	Band	Hex Code	Band
01H	0.1 ~ 0.5 MHz	0FH	10.5 ~ 12.0 MHz
02H	0.5 ~ 1.5 MHz	10H	12.0 ~ 14.0 MHz
03H	1.5 ~ 1.8 MHz	11H	14.0 ~ 14.5 MHz
04H	1.8 ~ 2.0 MHz	12H	14.5 ~ 15.0 MHz
05H	2.0 ~ 2.5 MHz	13H	15.0 ~ 18.0 MHz
06H	2.5 ~ 3.0 MHz	14H	18.0 ~ 18.5 MHz
07H	3.0 ~ 3.5 MHz	15H	18.5 ~ 21.0 MHz
08H	3.5 ~ 4.0 MHz	16H	21.0 ~ 21.5 MHz
09H	4.0 ~ 6.5 MHz	17H	21.5 ~ 22.0 MHz
0AH	6.5 ~ 7.0 MHz	18H	22.0 ~ 24.5 MHz
0BH	7.0 ~ 7.5 MHz	19H	24.5 ~ 25.0 MHz
0CH	7.5 ~ 8.0 MHz	1AH	25.0 ~ 28.0 MHz
0DH	8.0 ~ 10.0 MHz	1BH	28.0 ~ 29.0 MHz
0EH	10.0 ~ 10.5 MHz	1CH	29.0 ~ 30.0 MHz

#### Important Note!

The Hex Memory Channel Codes for returned memory data shown above (Byte 7) **are different** than those used in upload command data (opcodes)!

The memory channel hex codes used as argument (parameter) bytes for opcodes are *offset by one* (that is, one value greater) from their returned data counterparts. Therefore the channel hex codes used in opcodes 02H, 03H, and 8DH would range from 01H~71H.

When constructing command block bytes, ensure that the correct memory channel hex code is used!

The Band Selection data byte is divided into two 4-bit fields, representing the first and second value of the band number hex code. The Bit 0 and Bit 1 of the first field are used as flags for the memory

mask and scan skip feature. A bit value of "1" means enabled, and "0" for disabled. Each value of the hex code is entered into its respective field in 4-bit binary format. The table below outlines the Data Byte field, and show an example of how the 24.5~25.0 MHz band would be read as:

Band Selection Data Byte 0							
Bit 0*	Bit 1**	Bit 2	Bit 3	Bit 4	Bit 5	Bit 6	Bit 7
Field 1				Field 2			
0*	0**	0	1	1	0	0	1
*Mem. Mask	**Scan Skip	0001 = 1		1001 = 9			
"0" = Off "1" = On		19H = 24.5 ~ 25.0 MHz (refer to band chart)					

**Operating Frequency** - Likewise, the current operating frequency is similarly coded, this time into four bytes comprised of eight fields, from MSB to LSB. Base conversion must be done on the value to arrive at the actual frequency (binary-to-hexadecimal, then hexadecimal-to-decimal. For example, a read binary value of 0000 0000 0101 0000 0100 0010 0000 0001 would convert to 14.250.00 MHz as follows:

Operating Frequency Data Bytes (1-4)							
Byte 1		Byte 2		Byte 3		Byte 4	
Field 1 MSB	Field 2	Field 3	Field 4	Field 5	Field 6	Field 7	Field 8 LSB
0	0	0	1	0	1	0	0
0	0	0	0	0	0	0	1
0	0	5	0	4	2	0	1
00504201H = 1,425,000 (base conversion) 1,425,000 Hz = 14.250.00 MHz							

**Clarifier Offset** - Clarifier offset is written using 16-bit binary data in two bytes. Negative offsets are expressed in binary 2s-complement format, with a leading bit flag value\* of "1". Although frequency resolution below 10 Hz cannot be viewed, absolute clarifier offsets down to 0.625 Hz can be read from downloaded data.

Arithmetic conversion must be done on the binary value to arrive at the actual frequency offset (multiplying the 16-bit binary offset by 0.625). For example, a binary value of 0011 1110 0110 1111 (3E6FH or 15,983) multiplied by 0.625 results in an offset of +9989.375 Hz.

A value of 1100 0001 1001 0001 (the 2-s complement of the previous example) produces a minus offset of -9989.375 Hz. See the byte chart at the top of the next column for a breakdown of the conversion process.

Clarifier Offset Data Bytes (5-6)															
Byte 5							Byte 6								
1*	1	0	0	0	0	0	1	1	0	0	1	0	0	0	1
1* (flag) 100000110010001 = 4191H = 16,785 16,785 x 0.625 = (-) 9989.375 Hz															
*Note - Remember that the first bit is a flag: "0" for positive offsets, "1" for negative offsets, and is not included in calculations.															

**Operating Mode** - The operating mode is expressed as a three-bit binary code in offsets 5~7. Bit 0 contains a User Mode flag, while Bits 1~4 contain "dummy" values (unused).

Operating Mode Byte 7							
Bit 0*	Bit 1	Bit 2	Bit 3	Bit 4	Bit 5	Bit 6	Bit 7
User Mode	N/A - "dummy" bytes				Mode Data (3-bit Code)		
0	X	X	X	X	0	1	0
0XXXX010 = CW operation, User Mode Off							
0 = off 1 = on	Bits 1~3 are "dummy bits" - any 1/0 combination may appear in here, but is insignificant.				LSB 000 USB 001 CW 010 AM 011 FM 100 RTTY 101 PKT 110		

**IF Filter Selection** - The first data bit (Bit 0) contains a flag indicating normal or alternate reception mode (see table). The remainder of the data byte contains 2 x 4-bit fields separated by a dummy bit. The first field holds the 3-bit binary code for the 8.2 MHz 2nd IF filter selection, while the second holds the 455 kHz 3rd IF selection. Codes are listed in the bottom of the table below.

IF Filter Selection Byte 8							
Bit 0*	Bit 1	Bit 2	Bit 3	Bit 4	Bit 5	Bit 6	Bit 7
Rx Mode	8.2 MHz 2nd IF			X	455 kHz 3rd IF		
	Thru	000			6.0K	000	
	2.4K	001			2.4K	001	
	2.0K	010			2.0K	010	
	500	011			500	011	
	250	100			250	100	
<b>Mode*</b>	<b>CW</b>	<b>AM</b>	<b>RTTY</b>	<b>PKT</b>			
0	USB	ENV	LSB	LSB			
1	LSB	SYNC	USB	FM			

**VFO/MEM Indicators** - Five flags indicate the status of Clarifier (Rx & Tx), Repeater Offset (+/-), and Antenna Selection (A/B/RX). Bits 0 and 1 are not used (dummy values).

VFO / MEM Indicator Flags Byte 9							
Bit 0	Bit 1	Bit 2	Bit 3	Bit 4	Bit 5	Bit 6	Bit 7
X	X	ANT SELECT		-RPT	+RPT	RX CLAR	TX CLAR
Note: for all flag bits, 1= On, 0 = Off For ANT SEL: 00=ANT-A, 01=ANT-B, 10=RX ANT							



## Coding Examples

Although Yaesu Musen does not provide CAT control software (owing to the large variety of computers and operating systems used by our customers), the following are a few examples of critical CAT I/O functions, in Basic. Note that all variations of Basic may not support some of the commands, in which case alternate algorithms may need to be developed to duplicate the functions of those shown.

### *Sending a Command*

After "opening" the computer's serial port for 4800-baud, 8 data bits and 2 stop bits with no parity, as I/O device #2, any CAT command may be sent. However, if you determine that your computer may need extra time to process data returned from the transceiver, you should send the Pacing command first. Here is an example of the Pacing command setting a 2-ms delay:

```
PRINT #2,CHR$(0);CHR$(0);CHR$(0);CHR$(2);CHR$(&HE);
```

Notice that the instruction opcode is sent last, with the first (MSB) parameter sent just before it, and the LSB parameter (or dummies) sent first. This means that the parameters are sent in the reverse order from that in which they appear in the CAT Commands table. Also note that in this and the following examples, we are sending zeros as dummy bytes; this is not necessary, however. If you decide to send commands through a 5-byte array, the values of the dummy parameters need not be cleared. Also note the semicolon at the end of the line, to prevent Basic from sending extra bytes to "end the line" (the CAT system control system is based on binary streams, not text streams).

Using the same example as on page 74, the following command could be used to set the frequency of the display to 14.25000 MHz:

```
PRINT #2, CHR$(&H00); CHR$(&H50);CHR$(&H42);  
CHR$(&H01); CHR$(&HA);
```

Notice here that the BCD values can be sent just by preceding the decimal digits with "&H" in this example. However, in an actual program, it

may be preferable to convert the decimal frequency variable in the program to an ASCII string, and then to convert the string to characters through a lookup table.

If you send a parameter that is out of range for the intended function, or not among the specified legal values for that function, the FT-1000MP should do nothing. Therefore, you may wish to alternate your sending regular commands or command groups with the Read Flags or short-form Update commands, allowing the transceiver to let the computer know if everything sent so far has been accepted and acted upon as expected.

Bear in mind that some commands specify "binary", as opposed to BCD formatted parameters. You can send binary parameters without going through the character/hex string conversion process. For example, the CH parameter in the Command table is a binary value. You could have the FT-1000MP recall memory channel 50 (decimal) by the following:

```
PRINT#2,CHR$(0);CHR$(0);CHR$(0);CHR$(49);CHR$(2);
```

Note that we must send 49 to get channel 50, since the channel numbers in the command start from 0, while those on the display start with 1.

### *Reading Returned Data*

The reading process is easily done through a loop, storing incoming data into an array, which can then be processed after the entire array has been read. To read the meter:



```
FOR I=1 TO 5  
MDATA(I) = ASC(INPUT$(1,#2))  
NEXT I
```

Recall from above that the meter data consists of four identical bytes, followed by a filler byte, so we really only need to see one byte to get all of the information this command offers. Nevertheless, we must read all five bytes (or 1, 16, or 1,863, in the case of the Update data). After reading all of the data, we can select the bytes of interest to us from the array (MDATA, in the above example).

## CAT System Computer Control

### Legend:

**Send all commands in the order shown!** Commands that duplicate a front panel button are named with all caps or else have their key displayed. Parameter variables are labeled with letters, while “—” indicates a padding byte. Value is unimportant, but it must be present to pad the block out to five bytes.

Command or Key	Parameter Bytes				Opcode	Parameter Description
	1st	2nd	3rd	4th		
	—	—	—	T	01H	Split Tx/Rx operation ON (T=01H) or OFF(T=00H)
Recall Memory	—	—	—	X	02H	Recalls memory number X: 01H~71H, corresponding to memories 1~99, P1~P9, and QMB 1~5.
	—	—	K	X	03H	Enter (K=00H), Mask (K=01H) or Un-Mask (K=02H), memory channel X (01H~71H).
<b>LOCK</b>	—	—	—	P	04H	Tuning knob or panel lock/unlock: P=00H: Main dial lock    P=01H: Main dial unlock P=02H: Sub dial lock    P=03H: Sub dial unlock
<b>A/B</b>	—	—	—	V	05H	Select VFO-A (V=00H), or VFO-B (V=01H).
	—	—	—	X	06H	Copy memory X (01H~71H) to last-used VFO.
<b>▲UP</b>	—	—	U	V	07H	Step VFO-A /B (V=00H/01H) <i>up</i> by 100 kHz / 1 MHz (U=00H/01H)
<b>▼DOWN</b>	—	—	D	V	08H	Step VFO-A /B (V=00H/01H) <i>down</i> by 100 kHz / 1 MHz (D=00H/01H)
<b>CLAR</b>	C1	C2	C3	C4	09H	<i>Clarifier offset direction &amp; frequency in BCD</i>  C1= Hz offset            (C1=00~99H) C2= kHz offset         (C2=00~09H) C3= Direction (+/-)    (C3=00/FFH)  <i>Clarifier On/Off/Reset:</i>  C4= RX CLAR OFF/ON    (C4=00/01) TX CLAR OFF/ON    (C4=80/81) CLAR CLEAR         (C4=FFH)
Set Main VFO-A Operating Freq.	F1	F2	F3	F4	0Ah	New operating frequency in BCD format (F1~F4): see text for formatting example.
<b>MODE</b>	—	—	—	M	0CH	Select Operating Mode M:  LSB    M=00H        USB    M=01H        CW    M=02H CW (R) M=03H        AM     M=04H        AM(Sync) = 05H FM     M=06H        FM     M=07H        RTTY(L) = 08H RTTY(U) M=09H        PKT(L) M=0AH    PKT(F) = 0BH
<b>Pacing</b>	—	—	—	N	0EH	Add N-millisecs (00~FFH) delay between each byte of all downloaded data returned from the transceiver

**Legend:**

**Send all commands in the order shown!** Commands that duplicate a front panel button are named with all caps or else have their key displayed. Parameter variables are labeled with letters, while “—” indicates a padding byte. Value is unimportant, but it must be present to pad the block out to five bytes.

Command	Parameter Bytes				Opcode	Parameter Description
	1st	2nd	3rd	4th	5th	
PTT	—	—	—	T	0FH	Transmitter on (T=01H) or off (T=00H)
Status Update	X	—	—	U	10H	Instructs the radio to return 1, 16, 32, or 1863 bytes of Status Update data. X is significant only when U=1~4.  X=00H~71H desired memory channel (1~99, P1~P9, or QMB 1~5).  U=00H All 1863 bytes U=01H 1-byte Memory Channel Number U=02H 16-byte Operating Data U=03H 2 x16-byte VFO (A&B) Data U=04H 1x16 Byte Memory Data
Electronic Keyer	K1	K2	K3	K4	70H	Activates remote control and contest keyer functions.  K1=00H (fixed value) K2= keyer function:  00H = Message 0 (key #5) 01H = Message 1 (key #6) 02H = Message 2 (key #7) 03H = Message 3 (key #8) 04H = CQ/ID Message (key #1) 05H = Contest Number (key #2) 06H = Decrement Contest Number (key #4) 07H = Increment Contest Number (key #3) 08H = Message Playback w/o Tx (key #10) 09H = Write Message into Memory (key #9)  K3=01H (fixed value) K4=1BH (fixed value)
<b>EDSP</b>  Enhanced Digital Signal Processing  Settings and Parameters	—	—	P1	P2	75H	EDSP Settings, where P2 is:  Rx EDSP OFF (30H), P1 = 00H AM EDSP Demodulation On (31H), P1 = 00H  USB EDSP Demodulation (32H), with audio response of 100 Hz~3.1 kHz (P1=00H) or 300 Hz~2.8 kHz (P1=10H)  LSB EDSP Demodulation (33H), with audio response of 100 Hz~3.1 kHz (P1=00H) or 300 Hz~2.8 kHz (P1=10H)  AF Filter Off (40H), P1 = 00H AF LPF On (41H), where P1 = [F <sub>Cutoff</sub> (Hz)] / 20 (HEX format) AF HPF On (42H), where P1 = [F <sub>Cutoff</sub> (Hz)] / 20 (HEX format)  CW 240 Hz BWF (45H), where P1 = F <sub>Center</sub> (BCD format) CW 120 Hz BWF (46H), where P1 = F <sub>Center</sub> (BCD format)  (EDSP continued on following page)

**Legend:**

**Send all commands in the order shown!** Commands that duplicate a front panel button are named with all caps or else have their key displayed. Parameter variables are labeled with letters, while “—” indicates a padding byte. Value is unimportant, but it must be present to pad the block out to five bytes.

Command	Parameter Bytes				Opcode	Parameter Description																								
	1st	2nd	3rd	4th	5th																									
<b>EDSP</b> Enhanced Digital Signal Processing (Continued from previous page)	—	—	P1	P2	75H	EDSP Settings (continued from previous page), P2 = : CW 60 Hz BWF (47H), where P1 = F <sub>Center</sub> (BCD format) Data Mode AF Filter On (48H), where P1 = FSK (10H), SSTV(20H), Packet (30H), or FAX (40H). Random Noise Filter (4AH) Off / On (P1=00H / 1YH) Auto Notch Filter (4BH) Off / On (P1 = 00H / 10H) AF Equalization (4EH), where P1 = Off (00H), Bank 1 (10H), Bank 2 (20H), Bank 3 (30H), or Bank 4 (40H). Tx EDSP OFF (B0H) USB EDSP Modulation (B2H), with audio response of: 100 Hz~3.1 kHz (P1=10H), 150 Hz~3.1 kHz (P1=20H), 200 Hz~3.1 kHz (P1=30H), 300 Hz~3.1 kHz (P1=40H) LSB EDSP Modulation (B3H), with audio response of: 100 Hz~3.1 kHz (P1=10H), 150 Hz~3.1 kHz (P1=20H), 200 Hz~3.1 kHz (P1=30H), 300 Hz~3.1 kHz (P1=40H) Mic. Audio Equalization (C1H), where P1 = Off (00H), Bank 1 (10H), Bank 2 (20H), Bank 3 (30H), or Bank 4 (40H).																								
<b>TUNER</b>	—	—	—	T	81H	Switch antenna tuner On (T=01H) or Off (T=00H)																								
Tuner start	—	—	—	—	82H	Start antenna tuner																								
Dual Operation	—	—	—	D	83H	Switch dual receive On (D= 01H) or Off (D=00H)																								
<b>[RPT]</b>	—	—	—	R	84H	Select simplex operation (R=00H), -shift (R=01H), or +shift (R=02H) for repeater operation.																								
<b>[A-B]</b>	—	—	—	—	85H	Copy data displayed in VFO-A to VFO-B																								
Set SUB VFO-B Operating Freq.	F1	F2	F3	F4	8AH	Enter new operating frequency in F1 - F4, in BCD format: see text for example.																								
<b>BANDWIDTH</b> 2nd & 3rd IF Filter Selection	X1	—	—	X4	8CH	Select filter bandwidth for selected IF (see below): <table style="width:100%; border:none;"> <tr> <td style="text-align:center;"><b>8.2 MHz</b></td> <td style="text-align:center;"><b>455 kHz</b></td> <td style="text-align:center;"><b>VFO</b></td> <td></td> </tr> <tr> <td>THRU X4=04</td> <td>6.0kHz X4=84</td> <td>both X1=00</td> <td></td> </tr> <tr> <td>2.4 K X4=00</td> <td>2.4 K X4=80</td> <td>VFO-A X1=01</td> <td></td> </tr> <tr> <td>2.0 K X4=01</td> <td>2.0 K X4=81</td> <td>VFO-B X1=02</td> <td></td> </tr> <tr> <td>500 Hz X4=02</td> <td>500 Hz X4=82</td> <td></td> <td></td> </tr> <tr> <td>250 Hz X4=03</td> <td>250 Hz X4=83</td> <td></td> <td></td> </tr> </table>	<b>8.2 MHz</b>	<b>455 kHz</b>	<b>VFO</b>		THRU X4=04	6.0kHz X4=84	both X1=00		2.4 K X4=00	2.4 K X4=80	VFO-A X1=01		2.0 K X4=01	2.0 K X4=81	VFO-B X1=02		500 Hz X4=02	500 Hz X4=82			250 Hz X4=03	250 Hz X4=83		
<b>8.2 MHz</b>	<b>455 kHz</b>	<b>VFO</b>																												
THRU X4=04	6.0kHz X4=84	both X1=00																												
2.4 K X4=00	2.4 K X4=80	VFO-A X1=01																												
2.0 K X4=01	2.0 K X4=81	VFO-B X1=02																												
500 Hz X4=02	500 Hz X4=82																													
250 Hz X4=03	250 Hz X4=83																													
Memory Channel Scan Skip	—	—	S	X	8DH	Tag memory channels 1 thru 99 (X=01~6CH), to be skipped (S=01H) or included (S=00H) while scanning.																								
Step VFO-A Up/Down	—	—	—	T	8EH	Step frequency of VFO-A Up (T=00H) or Down (T=01H)																								

**Legend:**

**Send all commands in the order shown!** Commands that duplicate a front panel button are named with all caps or else have their key displayed. Parameter variables are labeled with letters, while “—” indicates a padding byte. Value is unimportant, but it must be present to pad the block out to five bytes.

Command	Parameter Bytes				Opcode	Parameter Description																																	
	1st	2nd	3rd	4th	5th																																		
CTCSS Encoder Tone Frequency Select	—	—	—	E	90H	<p>Select one of 33 CTCSS subaudible tones where E=00~20H. Refer to the tone list below.</p> <table border="0"> <tr> <td>E=00 67.0 Hz</td> <td>E=0B 118.8 Hz</td> <td>E=16 173.8 Hz</td> </tr> <tr> <td>E=01 71.9 Hz</td> <td>E=0C 123.0 Hz</td> <td>E=17 179.9 Hz</td> </tr> <tr> <td>E=02 77.0 Hz</td> <td>E=0D 127.3 Hz</td> <td>E=18 186.2 Hz</td> </tr> <tr> <td>E=03 82.5 Hz</td> <td>E=0E 131.8 Hz</td> <td>E=19 192.8 Hz</td> </tr> <tr> <td>E=04 88.5 Hz</td> <td>E=0F 136.5 Hz</td> <td>E=1A 203.5 Hz</td> </tr> <tr> <td>E=05 94.8 Hz</td> <td>E=10 141.3 Hz</td> <td>E=1B 210.7 Hz</td> </tr> <tr> <td>E=06 100.0 Hz</td> <td>E=11 146.2 Hz</td> <td>E=1C 218.1 Hz</td> </tr> <tr> <td>E=07 103.5 Hz</td> <td>E=12 151.4 Hz</td> <td>E=1D 225.7 Hz</td> </tr> <tr> <td>E=08 107.2 Hz</td> <td>E=13 156.7 Hz</td> <td>E=1E 233.6 Hz</td> </tr> <tr> <td>E=09 110.9 Hz</td> <td>E=14 162.2 Hz</td> <td>E=1F 241.8 Hz</td> </tr> <tr> <td>E=0A 114.8 Hz</td> <td>E=15 167.9 Hz</td> <td>E=20 250.3 Hz</td> </tr> </table>	E=00 67.0 Hz	E=0B 118.8 Hz	E=16 173.8 Hz	E=01 71.9 Hz	E=0C 123.0 Hz	E=17 179.9 Hz	E=02 77.0 Hz	E=0D 127.3 Hz	E=18 186.2 Hz	E=03 82.5 Hz	E=0E 131.8 Hz	E=19 192.8 Hz	E=04 88.5 Hz	E=0F 136.5 Hz	E=1A 203.5 Hz	E=05 94.8 Hz	E=10 141.3 Hz	E=1B 210.7 Hz	E=06 100.0 Hz	E=11 146.2 Hz	E=1C 218.1 Hz	E=07 103.5 Hz	E=12 151.4 Hz	E=1D 225.7 Hz	E=08 107.2 Hz	E=13 156.7 Hz	E=1E 233.6 Hz	E=09 110.9 Hz	E=14 162.2 Hz	E=1F 241.8 Hz	E=0A 114.8 Hz	E=15 167.9 Hz	E=20 250.3 Hz
E=00 67.0 Hz	E=0B 118.8 Hz	E=16 173.8 Hz																																					
E=01 71.9 Hz	E=0C 123.0 Hz	E=17 179.9 Hz																																					
E=02 77.0 Hz	E=0D 127.3 Hz	E=18 186.2 Hz																																					
E=03 82.5 Hz	E=0E 131.8 Hz	E=19 192.8 Hz																																					
E=04 88.5 Hz	E=0F 136.5 Hz	E=1A 203.5 Hz																																					
E=05 94.8 Hz	E=10 141.3 Hz	E=1B 210.7 Hz																																					
E=06 100.0 Hz	E=11 146.2 Hz	E=1C 218.1 Hz																																					
E=07 103.5 Hz	E=12 151.4 Hz	E=1D 225.7 Hz																																					
E=08 107.2 Hz	E=13 156.7 Hz	E=1E 233.6 Hz																																					
E=09 110.9 Hz	E=14 162.2 Hz	E=1F 241.8 Hz																																					
E=0A 114.8 Hz	E=15 167.9 Hz	E=20 250.3 Hz																																					
Read Meter & Panel Controls	M	—	—	—	F7H	<p>Instructs radio to return digitized indications of various meter level readings and front panel control settings (4 repeated bytes, and F7H) selected by:</p> <table border="0"> <tr> <td>M=00H Main S-Meter</td> <td>M=87H TUN Meter</td> </tr> <tr> <td>M=01H Sub S-Meter</td> <td>M=F0H Shuttle Jog Dial</td> </tr> <tr> <td>M=80H PO Meter</td> <td>M=F1H CW Pitch setting</td> </tr> <tr> <td>M=81H ALC Meter</td> <td>M=F2H Remote Control A/D level</td> </tr> <tr> <td>M=83H IC Meter</td> <td>M=FH3 SHIFT setting</td> </tr> <tr> <td>M=84H VCC Meter</td> <td>M=F4H WIDTH setting</td> </tr> <tr> <td>M=85H SWR Meter</td> <td>M=F5H EDSP Contour selection</td> </tr> <tr> <td>M=86H MIC Meter</td> <td>M=F6H EDSP NR selection</td> </tr> </table>	M=00H Main S-Meter	M=87H TUN Meter	M=01H Sub S-Meter	M=F0H Shuttle Jog Dial	M=80H PO Meter	M=F1H CW Pitch setting	M=81H ALC Meter	M=F2H Remote Control A/D level	M=83H IC Meter	M=FH3 SHIFT setting	M=84H VCC Meter	M=F4H WIDTH setting	M=85H SWR Meter	M=F5H EDSP Contour selection	M=86H MIC Meter	M=F6H EDSP NR selection																	
M=00H Main S-Meter	M=87H TUN Meter																																						
M=01H Sub S-Meter	M=F0H Shuttle Jog Dial																																						
M=80H PO Meter	M=F1H CW Pitch setting																																						
M=81H ALC Meter	M=F2H Remote Control A/D level																																						
M=83H IC Meter	M=FH3 SHIFT setting																																						
M=84H VCC Meter	M=F4H WIDTH setting																																						
M=85H SWR Meter	M=F5H EDSP Contour selection																																						
M=86H MIC Meter	M=F6H EDSP NR selection																																						
Repeater Offset	X1	X2	X3	X4	F9H	<p>Set offset for RPT shifts, valid values are 0 - 500 kHz in 1-kHz steps. Use BCD format for X2 ~ X4):</p> <table border="0"> <tr> <td>X1 is 10's &amp; 100's of Hz</td> <td>X2 is 1's &amp; 10's of kHz</td> </tr> <tr> <td>X3 must be 00, 01 or 02</td> <td>X4 must be 00H</td> </tr> </table>	X1 is 10's & 100's of Hz	X2 is 1's & 10's of kHz	X3 must be 00, 01 or 02	X4 must be 00H																													
X1 is 10's & 100's of Hz	X2 is 1's & 10's of kHz																																						
X3 must be 00, 01 or 02	X4 must be 00H																																						
Read Internal Status Flags	—	—	—	F	FAH	<p>Instructs radio to return either five or six status flag bytes.</p> <table border="0"> <tr> <td><b>5-Byte Format (F=00H)</b></td> <td><b>6-Byte Format (F=01H)</b></td> </tr> <tr> <td>Status Flag Byte #1</td> <td>Status Flag Byte #1</td> </tr> <tr> <td>Status Flag Byte #2</td> <td>Status Flag Byte #2</td> </tr> <tr> <td>Status Flag Byte #3</td> <td>Status Flag Byte #3</td> </tr> <tr> <td>*ID Byte #1 (03H)</td> <td>Status Flag Byte #4</td> </tr> <tr> <td>*ID Byte #2 (93H)</td> <td>Status Flag Byte #5</td> </tr> <tr> <td></td> <td>Status Flag Byte #6</td> </tr> </table> <p>* See page 76 for explanation of transceiver ID byte values.</p>	<b>5-Byte Format (F=00H)</b>	<b>6-Byte Format (F=01H)</b>	Status Flag Byte #1	Status Flag Byte #1	Status Flag Byte #2	Status Flag Byte #2	Status Flag Byte #3	Status Flag Byte #3	*ID Byte #1 (03H)	Status Flag Byte #4	*ID Byte #2 (93H)	Status Flag Byte #5		Status Flag Byte #6																			
<b>5-Byte Format (F=00H)</b>	<b>6-Byte Format (F=01H)</b>																																						
Status Flag Byte #1	Status Flag Byte #1																																						
Status Flag Byte #2	Status Flag Byte #2																																						
Status Flag Byte #3	Status Flag Byte #3																																						
*ID Byte #1 (03H)	Status Flag Byte #4																																						
*ID Byte #2 (93H)	Status Flag Byte #5																																						
	Status Flag Byte #6																																						



# Menu Selection and Settings

## Introduction

In the last chapter, basic and advanced operation were covered to explain the various transceiver features. This chapter covers all of the menu selections entries and their settings used by the transceiver. These functions were described previously, but must be configured as desired using menu programming. Menu selections are shown as they appear in the display to assist you as you go along.

## Menu Selections

Eighty-two transceiver settings are contained in programming menu (refer to the menu list shown on the opposite page). To view and edit menu selections, press **FAST** :



The SUB VFO-B display shows the selection name, while MAIN VFO-A display shows the current (default) setting.

Rotating the **MEM/VFO CH** knob displays the various selections, whose numbers appear in the memory channel box.

Rotating the Main VFO knob lets you choose between the various settings available for the displayed selection. Some settings are merely an off/on switch, while others are variable tuning step sizes, time and frequency values, or mode choices.

0-1 GrP1-CH

Selects the number of default memory channels (from 1-99) made available from within group 1. If all 99 memory channels are enabled, group 2 is not configurable.

0-2 GrP2-CH

Selects the number of default memory channels (from 1-99) made available from within group 2 if less than 99 memory channels are enabled in group 1. If all 99 memory channels are enabled, group 3 is not configurable.

0-3 GrP3-CH

Selects the number of default memory channels made available from within group 3 if groups 1 and 2 are not configured for 99 channels total. If all 99 memory channels are enabled, group 4 is not configurable.

0-4 GrP4-CH

Selects the number of default memory channels made available from within group 4 if groups 1, 2, & 3 are not configured for 99 channels total. If all 99 memory channels are enabled, group 5 is not configurable.

0-5 GrP5-CH

Selects the number of default memory channels made available from within group 5 (to 99 total) if groups 1, 2, 3 & 4 are not configured for 99 channels total.

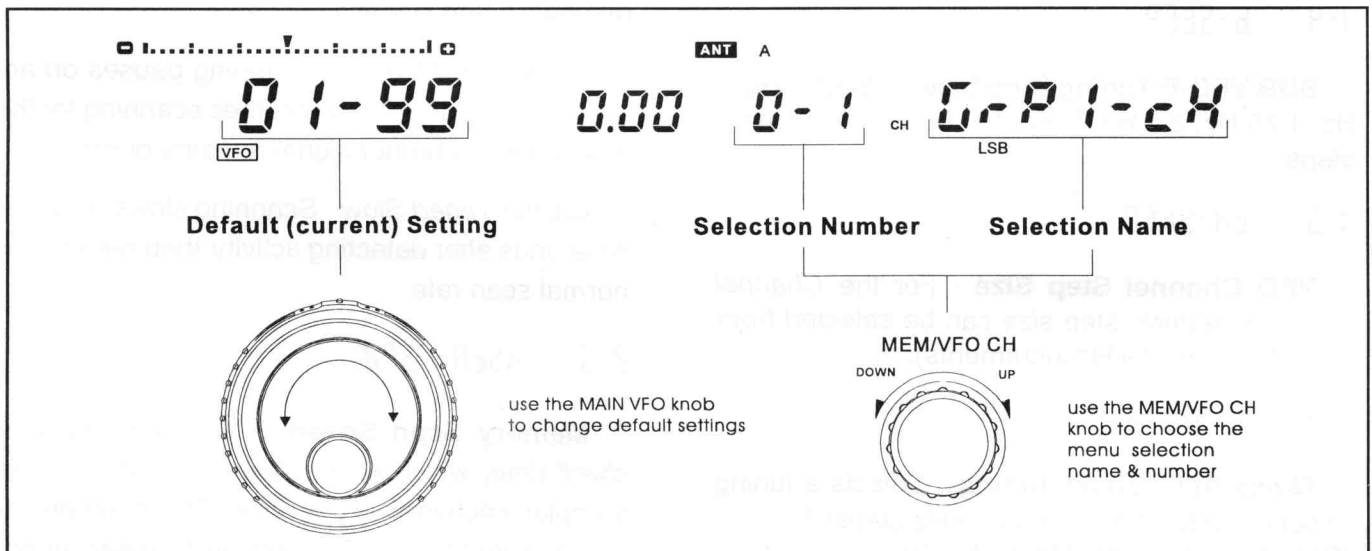

### 0-6 Quick-Memory

**Quick Memory Bank Channels** - Allocates 1 to 5 memories for use with the instant-write "quick-memory" feature.

### 0-8 Auto-Up

**Auto Channel Up** - When programming memories from the VFO, this feature automatically increments selection to the next higher memory channel. This allows programming sequential memories more easily (you don't have to manually select the next memory to be written). This also prevents inadvertently overwriting stored memories.

### 1-0 VFO A & B Dial FAST

**VFO A & B Dial FAST Tuning Rate** - Selects x2 or x4 tuning when the FAST button is pressed.

### 1-1 Shuttle Jog Encoder Speed

**Shuttle Jog Encoder Speed** - Select the encoder pulse duration from 1 ~ 100 msec (in 1 msec steps).

### 1-2 IF SHIFT/WIDTH Control

**IF SHIFT/WIDTH Control Tuning Step Size** - Selects 10 or 20-Hz step size. Total knob tuning range is 62 encoder steps (with 20-Hz step size the shift range is double that with 10-Hz).

### 1-3 MAIN VFO-A

**MAIN VFO-A Tuning Step Size** - Selects 0.625 Hz, 1.25 Hz, 2.5 Hz, 5 Hz, 10 Hz, or 20 Hz tuning steps.

### 1-4 SUB VFO-B

**SUB VFO-B Tuning Step Size** - Selects 0.625 Hz, 1.25 Hz, 2.5 Hz, 5 Hz, 10 Hz, or 20 Hz tuning steps.

### 1-5 Channel Stepping

**VFO Channel Step Size** - For the *Channel Stepping* feature, step size can be selected from 1 ~ 100 kHz (in 1-kHz increments).

### 1-6 Quick Split

**Quick Split Offset Tuning** - Selects a tuning offset of up to  $\pm 100$  kHz (in 1-kHz steps).\* (See Menu 8-2: Split Mode, A = B).

### 1-7 AutoFAST

**Automatic Selecting of AGC decay time** - When the front panel AGC selector is set to the "AUTO" position and this feature is "ON," the AGC decay time automatically is set to "FAST" during the following operating situations:

- During scanning;
- In 250/500 Hz bandwidth; and
- When you turn the VFO Knob for more than 1/2-second.

### 1-8 Clarifier Tuning

**Clarifier Tuning Offset** - Enables/disables the offset tuning meter above the MAIN VFO-A frequency display. As the CLAR control is rotated and the TX or RX frequency is offset, a single meter segment shifts to show your relative offset from the original frequency.

### 1-9 Clarifier Step

**Clarifier Tuning Step Size** - Selects 0.625 Hz, 1.25 Hz, 2.5 Hz, 5 Hz, 10 Hz, or 20 Hz tuning steps used with the RX & TX CLAR control.

### 2-0 Scan Pause

**Scan Pause** - Enables/disables pausing on activity while scanning.

### 2-1 Scan Resume

**Scan Resume Mode** - Selects one of three scan-stop modes:

*Carrier Stop* - Scanning pauses on activity, resumes when signal disappears.

*Carrier Timed Stop* - Scanning pauses on activity for 5 seconds then resumes scanning for the next station (whether signal remains or not).

*Carrier Timed Slow* - Scanning slows down for 5 seconds after detecting activity, then resumes to normal scan rate.

### 2-3 Memory Scan

**Memory Scan Speed** - This sets the scan *dwell time*, which is the duration that scanning samples each memory channel. This duration can be set from 100 ~ 1000 msec, in 10 msec steps.



2-4 dScn-SPd

**Dial (VFO) Scan Speed** - This sets the *dwell time* that scanning samples each VFO channel. This duration can be set from 1 ~ 100 msec, in 1 msec steps.

2-5 Auto-m

**Auto Memory Write** - When enabled, active channels found during scanning are automatically written into ascending memory channels of Group 1, or all groups, until full.

2-6 ScAn-ALL

**Memory Scan Skip** - Enables/disables the memory scan skip feature. When OFF, memories marked for scan skip will be passed over during scanning. When ON, all memories are scanned.

2-7 Sc-dL t

**Scan Delay Time** - Selects a scanning delay time of 1 ~ 5 seconds. This determines how long scanning pauses on activity before resuming.

2-8 notch

**Notch Operation** - Selects Notch Filter operation:

*IF NOTCH* - Manual IF notch operation using the front panel knob with the same name.

*AUTO DSP* - When the **NOTCH** button is pressed, the EDSP multiple notch circuit automatically locates existing heterodynes and notches them. Any additional heterodynes are also notched as they appear.

*SELECT* - The EDSP button controls notch mode activation. If EDSP is *active* and the **NOTCH** button is pressed, Auto-Notch and IF notch operation take effect simultaneously. With EDSP *disabled*, manual IF notch operation is activated.

3-0 F-dSPLY

**Frequency Display Format**

*Carrier* - Displays the actual carrier frequency, without any offset added. When changing modes, the frequency display remains constant.

*Offset* - When changing modes, the frequency display changes to reflect the added BFO offset.

3-1 dSP-rES

**Display Resolution** - Selects 10 Hz, 100 Hz, or 1 kHz display frequency resolution for the main and sub-VFO displays. Note that this setting does not affect tuning step size.

3-2 EES-SEL

**Expanded Tuning Scale** - Selects the display format of the expanded tuning scale located above the main frequency display:

*Dial* - Permits sub-resolution tuning and display using small sub-increment segments that expand outward as the dial is turned.

*Clarifier* - Permits viewing relative Rx or Tx clarifier offset from the displayed frequency. A single segment moves left or right from center as the **CLAR** knob is rotated.

3-3 tr-dSP

**Transverter Display** - Selects 50, 144, or 430 to be displayed in the 1's, 10's, and 100's of the MHz places for operation with a transverter.

3-4 br 19Hz

**LCD Display Brightness** - Enables adjusting the display intensity between high or low.

3-5 Panel-diSP

**Panel Offset Display Mode** - Selects one of four parameters to be viewed in the smaller sub-display to the right of the MAIN VFO-A frequency display:

*Clarifier* - Displays "clarified" frequency offset  $\Delta F_{rx}$  or  $\Delta F_{tx}$  from original frequency.

*Channel Freq.* - Displays the operating frequency contained in the selected memory channel.

*Offset* - Displays the frequency difference (offset) between the displayed MAIN VFO-A and SUB VFO-B frequencies.

*A1 (CW) Pitch* - Displays the default CW pitch setting.

3-6 S-bar dSP

**Sub-Meter Bar Graph** - Enables the S-meter bargraph segment display for SUB VFO-B.

### 3-7 P-Hold

**Main Meter Peak-Hold** - Enables/disables peak-hold feature, and selects display bar/segment persistence (delay time) from 10 ~ 2000 msec.

### 3-8 SP-Hold

**Sub Meter Peak Hold** - Enables/disables peak-hold feature, and select display bar/segment persistence (delay time) from 10 ~ 2000 msec.

### 4-0 RF-out

**RF Power Output Range** - Selects a maximum RF power output limit of 100W, 50W, or 10W.

### 4-1 bEEP

**Key & Panel Beeper** - Enables/disables the beep that sounds when a front panel key or button is pressed.

### 4-2 bEEP-F

**Beep Frequency** - Adjusts the front panel key & button beep pitch from 220 ~ 7040 Hz. By turning the VFO-B knob slightly so that bEEP-tun appears, a constant pitch matches the displayed pitch, which is adjusted using the MAIN VFO-A knob. **Note** - beep volume can be adjusted via the hole on the bottom case of the transceiver. Insert a small insulated screwdriver and slowly turn the trimmer for the desired volume.

### 4-3 tun-drv

**Tune-up Drive Power** - Selects a maximum output power limit of 10, 50, or 100 W for driving the input circuit of an external linear RF amplifier while tuning (while using the Remote Control function).

### 4-4 tr-EDSP

**Transmit Audio EDSP** - Disables or selects one of four available EDSP equalization schemes for transmitted microphone audio. Select the one that best suits your voice characteristics by activating the monitor circuit, transmitting, and switching through each type while comparing each effect.

### 4-5 EDSP-F 1

**EDSP Receive Band Pass Filters** - Tailor the frequency response for the four available receiver EDSP Band Pass Filter networks:

*SSB High Cutoff* - This adjusts the high frequency cutoff for the SSB BPF. Signals above this frequency are rejected. The upper cutoff frequency is adjustable from 1000 ~ 3200 Hz.

*SSB Low Cutoff* - This adjusts the low frequency cutoff for the SSB BPF. Signals below this frequency are rejected. The lower cutoff frequency is adjustable from 100 ~ 1800 Hz.

*CW BPF* - This selects the total bandwidth for the band-pass filter, which passes a range of frequencies falling within an upper and lower pair of cutoff frequencies. Bandwidths of 60-, 120-, and 240-Hz are selectable.

*AM High Cutoff* - This adjusts the high frequency cutoff for the AM BPF. Signals above this frequency are rejected. The upper cutoff frequency is adjustable from 1000 ~ 3200 Hz.

*AM Low Cut* - This adjusts the low frequency cutoff for the AM BPF. Signals below this frequency are rejected. The lower cutoff frequency is adjustable from 100 ~ 1800 Hz.

*Digital Mode Filter* - selects one of three preset filters optimized for FAX, PACKET or SSTV operation.

### 4-6 dvs-rec

**DVS Record VFO** - Selects MAIN VFO-A or SUB VFO-B as the receive audio source to record from, when using the optional DVS-2 (Digital Voice System).

### 4-7 dvs-ptt

**DVS-2 PTT** - Enables/disables transmitter PTT control from the DVS-2 unit.

### 4-8 HEADPHON

**Headphone Mode** - Selects one of three audio mixing modes for use with headphones:

*Mono* - Audio from both the MAIN and SUB VFOs is combined and heard the same in both ears.

*STEREO 1* - Audio from both the MAIN VFO-A and SUB VFO-B can be heard in each ear, but SUB VFO audio is attenuated in the left ear and MAIN VFO audio is attenuated in the right.

**STEREO 2** - Audio from MAIN VFO-A is heard only in the left ear and SUB VFO-B in the right.

**Note:** both VFOs must be activated by the **DUAL** button on the front panel, and the main and sub audio must be balanced using the **MAIN** and **SUB AF GAIN** controls.

4-9 AF-GR in

**AF GAIN Control** - Selects the operation of the **MAIN SUB AF GAIN** front panel control:

**Balanced** - The audio level for both VFOs is adjusted by the inner control, while the outer collar adjusts the balance.

**Separate** - The audio level for each VFO is adjusted separately (inner knob for MAIN VFO volume, outer collar for SUB VFO volume).

5-0 0.2-2.4

**2nd IF 2.4 kHz Filter** - Enables/disables the factory-installed 2.4 kHz IF filter for front-panel **BANDWIDTH** selection.

5-1 0.2-2.0

**2nd IF 2.0 kHz Filter** - Enables/disables the optional 2.0 kHz IF filter (Yaesu P/N YF-114SN) for front-panel **BANDWIDTH** selection.

5-2 0.2-500

**2nd IF 500 Hz Filter** - Enables/disables the factory-installed 500 Hz IF filter for front-panel **BANDWIDTH** selection.

5-3 0.2-250

**2nd IF 250 Hz Filter** - Enables/disables the optional 250 Hz IF filter (Yaesu P/N YF-114CN) for front-panel **BANDWIDTH** selection.

5-4 455-2.4

**3rd IF 2.4 kHz Filter** - Enables/disables the factory-installed 2.4 kHz IF filter for front-panel **BANDWIDTH** selection.

5-5 455-2.0

**3rd IF 2.0 kHz Filter** - Enables/disables the optional 2.0 kHz IF filter (Yaesu P/N YF-110SN) for front-panel **BANDWIDTH** selection.

5-6 455-500

**3rd IF 500 Hz Filter** - Enables/disables the optional 500 Hz IF filter (Collins YF-115C) for front-panel **BANDWIDTH** selection.

5-7 455-250

**3rd IF 250 Hz Filter** - Enables/disables the optional 250 Hz IF filter (Yaesu P/N YF-110CN) for front-panel **BANDWIDTH** selection.

5-8 Sub-F IL

**SUB VFO Filter** - Enables/disables optional SUB VFO-B 2nd IF 500-Hz CW filter (Collins YF-115C).

5-9 T-F 11

**TX EDSP Filter** - Selects either a 6.0-kHz or 2.4-kHz digital bandpass filter for early-stage transmit audio tailoring.

6-0 rttY-5KF

**RTTY Frequency Shift** - Selects 170, 425, or 850 Hz standard frequency shift for FSK RTTY operation.

**Important Note!** - If changing RTTY shift to other than 170 Hz, be sure to re-calibrate the tuning meter as outlined on page 72. The calibration routine is simple, and ensures your center tuning indication matches the tone pair.

6-1 rttY-Pol

**RTTY Polarity** - Selects normal or reverse Mark/Space polarity for RTTY operation. Normal operation utilizes a 2125-Hz mark frequency, while reverse uses 2295 Hz. See the table on page 54 for a list of standard tone pairs.

6-2 rtt-tan

**RTTY Tone** - Selects high or low mark tone for RTTY operation. See the table on page 54 for a comparison of high/low tone pairs.

6-3 rttY-FdSP

**RTTY Frequency Display** - Selects the type of display offset that appears during RTTY operation.

**Offset** - Displays the RTTY BFO offset.

**Carrier** - Displays the actual carrier frequency.

### 6-4 PRc-FdSP

**Packet Frequency Display Offset** - You can offset the frequency readout to display the *center* frequency between the two transmitted carriers (tone pairs). Rotate the MAIN VFO-A knob to adjust the display offset, or else set to 0.00 to display the actual carrier frequency. See menu selection 6-5 below for tone pair selection.

### 6-5 PRc-tOnE

**Packet Tones** - Selects one of four available packet tone pairs (1070/1270Hz, 1600/1800Hz, 2025/2125Hz or 2110/2130Hz). The frequency displayed is actually the *center* frequency of the selected tone pair.

**Important Note!** - If changing the packet tone pair to other than 2025/2225 Hz, be sure to re-calibrate the tuning meter as outlined on page 72. The calibration routine is simple, and ensures your center tuning indication matches the tone pair.

### 6-7 [t[55

**CTCSS Repeater Tone** - Selects one of 33 CTCSS (Continuous Tone Coded Squelch System) tones to be transmitted to access repeaters that require them. By default, 88.5 Hz is enabled.

### 6-8 tOnE-SEt

**Repeater Tone Setting** - Selects continuous tone or burst tone mode for CTCSS operation.

### 6-9 rPt-5HFt

**Repeater Shift** - Selects the desired TX frequency offset (shift) from the displayed Rx frequency to access repeaters. Standard shift is 100 kHz for 29-MHz FM repeaters.

### 7-0 tEYEr

**Keyer Mode Selection** - Selects the desired keyer emulation mode for the built-in electronic keyer:

**IAMBIC 1** - Iambic keyer with ACS (Automatic Character Spacing) disabled. Weighting is user-selectable via menu selections 7-1 and 7-2.

**BUG** - Mechanical “bug” keyer emulation. One paddle produces “dits” automatically, while the other paddle manually produces “dahs.”

**IAMBIC 2** - Iambic keyer with ACS enabled. Weighting is set via menu selections 7-1 and 7-2.

### 7-1 tYr-dot

**CW “Dot” Weighting** - Adjusts dot character weight from 1 ~ 127 (10 by default).

### 7-2 tYr-d5H

**CW “Dash” Weighting** - Adjusts dash character weight from 1 ~ 127 (30 by default).

### 7-3 cOnSt-nO

**Contest Keyer ID** - Enters the initial 4-digit number that will increment/decrement after sending during contest QSOs.

### 7-4 bt-in-t

**Break-In Time Delay** - Selects the time delay from 0~30 ms (5 ms default) between when the PTT is keyed and the carrier is transmitted during QSK operation.

### 7-5 tYr-dEL

**Keyer Delay** - Selects the time delay from 0.00 ~ 5.10 seconds (0.00 secs. by default) during which the transmitter remains keyed after you stop sending.

### 7-6 R1-5 tYL

**CW Playback Style** (for Contest Number) - Determines the “Cut” number format playback for the CW Contest Number (see menu selection 7-3). The selected number will be played back in “Cut” format (see the chart on page 61).

### 7-7 dSP-ndn

**EDSP Enhanced Modulation & Demodulation** - This processes received and transmitted audio at the 4th IF level (10.24 kHz) for enhanced band pass filtering and audio response tailoring.

Four individual EDSP modes are selected with the SUB VFO-B dial, while frequency response choices are adjusted using the MAIN VFO-A dial:

**SSB (Rx)** - Selects 100~3100Hz, or 300~2800Hz filter response, or OFF.

**SSB (Tx)** - Selects 100~3100 Hz, 150~3100 Hz, 200~3100 Hz, or 300~3100 Hz filter response, or OFF.

**CW (Rx)** - Selects 100~3100 Hz filter response, or OFF.

**AM (Rx)** - Selects 70~3800 Hz filter response, or OFF.

7-8 Sub-rcvr

**Sub VFO Receiver** - Enables or disables the SUB VFO-B receiver from operation. If disabled, you can temporarily turn on the Sub receiver by pressing **DUAL**, or the SUB VFO-B **RX** button/LED.

7-9 rc-func

**Remote Control Function**- Selects the active feature for remote control operation. **Note** - Remote control operation requires a 12-switch input keyboard for operation; see the description and charts on pages 60-63 for details of operation.

**Keyer** - Activates contest keyer operation.

**Function Keys** - Emulate front panel Memory Control keys.

**VFO-A** - Enables direct-frequency input to VFO-A by emulating the front panel keypad keys.

**VFO-B** - Enables direct-frequency input to VFO-B by emulating the front panel keypad keys.

8-0 FAST-SET

**FAST Button Operation** - Selects front-panel FAST button actuation:

**Momentary** - Press and hold to engage fast tuning.

**Continuous** - Toggle on/toggle off fast tuning.

8-1 Lock-SEL

**LOCK Button Operation** - Chooses between

**Dial** - Locks MAIN VFO-A knob only

**Panel** - Locks front panel buttons & keys (refer to drawing below).

**Primary** - locks front panel primary function keys (refer to drawing below).

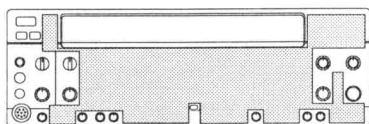

**Panel Lock** - when the Main VFO (A) lock is pressed, all controls within the shaded area are disabled.

When the Sub VFO (B) lock is pressed, only the SUB VFO tuning knob is disabled.

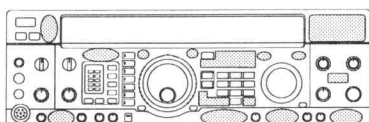

**Primary Lock** - when the Main VFO (A) lock is pressed, only the MAIN VFO tuning knob is disabled.

When the Sub VFO (B) lock is pressed, all controls within the shaded areas are disabled.

8-2 SPLIT-SET -

**Split Mode Operation** - Selects one of three split operating modes:

**Normal** - In this default mode, pressing **SPLIT** activates SUB VFO-B for transmission. Other settings (such as mode and frequency) must be manually set for the Sub VFO.

**Auto** - When **SPLIT** is pressed, SUB VFO-B is enabled for transmit, and the selected operating mode from MAIN VFO-A is automatically copied into SUB VFO-B.

**A=B** - Same as Auto mode above; however, a preset frequency offset is applied to SUB VFO-B for transmission (see Menu 1-6: Quick Split).

8-4 Front End

**Receiver Front-End RF Amplifier** - Selects the desired receiver front-end amplifier configuration:

**Flat** - A broadband amplifier with flat response.

**Tuned** - A separate tuned amplifier for low and high bands.

8-5 Ant-SEL

**Antenna Selection** - Chooses between:

**AUTO** - Antenna selections are automatically copied along with other operating parameters during memory programming.

**ON** - Enables front panel **ANT** switch.

**OFF** - Disables the front panel **ANT** switch (only ANT-A is selected).

8-6 USER-SET

**User Setting** - This configures an operating "environment" selected by pressing the front-panel **USER** button. Operating parameters are selected using the SUB VFO-B knob, while options are chosen with the MAIN VFO-A knob.

**Mode** - This selects to which mode the custom settings are applied. Choose LSB, USB, CW (normal/reverse), RTTY (normal/reverse), or packet (LSB only).

**Display Offset** - You can choose a custom offset  $\pm 5.000$  kHz (in 5-Hz steps) to take effect when the User mode is active. The default offset is dependent upon operating mode.

## Menu Programming - Selection & Settings

**Rx PLL Offset** - You can offset the receiver PLL frequency  $\pm 5.000$  kHz (in 5-Hz steps) when the **USER** button is pressed.

**Rx Carrier** - This is used to adjust the receive carrier injection frequency between 450~460 kHz. The default injection frequency is dependent upon operating mode.

**Tx PLL Offset** - You can offset the transmitter PLL frequency  $\pm 5.000$  kHz (in 5-Hz steps) when the **USER** button is pressed.

**Tx Carrier** - This is used to adjust the transmit carrier injection frequency between 450.000~453.700 kHz or 456.300~460.000 kHz (PKT), 456.300~460.000 kHz (LSB), 450.000~453.700 kHz (USB), or between 450.000~460.000 kHz (all others). The default injection frequency is dependent upon operating mode.

**RTTY Offset (shift)** - For operators who desire to use a non-standard mark/space shift (that is, other than 170/425/850 Hz), a custom shift ( $\pm 5.000$  kHz in 5-Hz steps) can be chosen. The mark is the carrier frequency, while the space is offset above or below the carrier by the value of this setting. For best results, we recommend limiting shift to  $\pm 1.000$  kHz or less.

**Easy Set** - If you enjoy operating FAX or SSTV, you can select on of these for the User mode. The carrier and offset options for both settings come factory pre-configured and optimized for best operation.

8-7 Sub-AGC

**SUB VFO Receiver AGC** - Selects automatic, slow, or fast AGC recovery time for the Sub VFO-B receiver.

8-8 Tuner

**Antenna Tuner** - Enables or disables the internal automatic antenna tuner unit for operation.

8-9 Cr of St

**Carrier Point Offset** - This allows shifting the carrier point IF passband on both Tx and Rx to tailor the received audio response, as well as your transmitted voice audio. This can be used to customize your signal for your own voice characteristics. Seven individual carrier settings are selected with the SUB VFO-B dial, while offsets are adjusted (in 10-Hz steps) using the MAIN VFO-A dial:

**Rx LSB Carrier** - Adjusts the receiver carrier point for LSB throughout the range of -200 ~ +500 Hz.

**Tx LSB Carrier** - Adjusts the transmitter carrier point for LSB throughout the range of -200 ~ +500 Hz.

**Processor LSB** - Adjusts the speech processor carrier point for LSB throughout the range of -200 ~ +500 Hz.

**Rx USB Carrier** - Adjusts the receiver carrier point for USB throughout the range of -200 ~ +500 Hz.

**Tx USB Carrier** - Adjusts the transmitter carrier point for USB throughout the range of -200 ~ +500 Hz.

**Processor USB** - Adjusts the speech processor carrier point for USB throughout the range of -200 ~ +500 Hz.

**Tx AM Carrier** - Adjusts the transmitter carrier point for AM throughout the range of  $\pm 3000$  Hz.

**Note:** See the table on the next page for a complete list of filter offsets according to mode, and custom frequency and display offsets.

### Easy Recall Menus

Several frequently-used menu functions can be accessed directly via two keystrokes from the front panel;

Hold	while pressing...	to access:
FAST	NOTCH	2-9 notch
FAST	VCC/MIC	3-4 bright
FAST	EDSP	4-5 EDSP Fil
FAST	BK-IN	7-5 KYR-dly
FAST	RX-(Sub VFO)	8-9 SUB AGC

## Custom Frequency &amp; Display Offset Information

MODE		1st Fc = F + 70.455 BFO (kHz)					
		RX	TX	RX	TX		
SSB	LSB USB	-1500 Hz +1500 Hz	-1500 Hz +1500 Hz	465.5 kHz 453.5 kHz	465.5 kHz 453.5 kHz		
CW	400 Hz	0	0	454.6 kHz	455.0 kHz		
	500 Hz	0	0	454.5 kHz	455.0 kHz		
	600 Hz	0	0	454.4 kHz	455.0 kHz		
	700 Hz	0	0	454.3 kHz	455.0 kHz		
	800 Hz	0	0	454.2 kHz	455.0 kHz		
CW-R	400 Hz	0	0	455.4 kHz	455.0 kHz		
	500 Hz	0	0	455.5 kHz	455.0 kHz		
	600 Hz	0	0	455.6 kHz	455.0 kHz		
	700 Hz	0	0	455.7 kHz	455.0 kHz		
	800 Hz	0	0	455.8 kHz	455.0 kHz		
AM	Synchronous	0	0	-	455.0 kHz 455.0 kHz		
FM	Narrow	0	0	-	-		
					Mark	Space	
RTTY-L	H 170 Hz	- 85.00 Hz	- 85.00 Hz	457.2100 kHz	455.0850 kHz	454.9150 kHz	
	H 425 Hz	- 212.5 Hz	- 212.5 Hz	457.3375 kHz	455.2125 kHz	454.7875 kHz	
	H 850 Hz	- 425.0 Hz	- 425.0 Hz	457.5500 kHz	455.4250 kHz	454.5750 kHz	
	L 170 Hz	- 85.00 Hz	- 85.00 Hz	456.3600 kHz	455.0850 kHz	454.9150 kHz	
	L 425 Hz	- 212.5 Hz	- 212.5 Hz	456.4875 kHz	455.2125 kHz	454.7875 kHz	
RTTY-U	L 850 Hz	- 425.0 Hz	- 425.0 Hz	456.7000 kHz	455.4250 kHz	454.5750 kHz	
	H 170 Hz	+ 85.00 Hz	+ 85.00 Hz	452.7900 kHz	455.0850 kHz	454.9150 kHz	
	H 425 Hz	+ 212.5 Hz	+ 212.5 Hz	452.6625 kHz	455.2125 kHz	454.7875 kHz	
	H 850 Hz	+ 425.0 Hz	+ 425.0 Hz	452.4500 kHz	455.4250 kHz	454.5750 kHz	
	L 170 Hz	+ 85.00 Hz	+ 85.00 Hz	453.6400 kHz	455.0850 kHz	454.9150 kHz	
	L 425 Hz	+ 212.5 Hz	+ 212.5 Hz	453.5125 kHz	455.2125 kHz	454.7875 kHz	
	L 850 Hz	+ 425.0 Hz	+ 425.0 Hz	455.4250 kHz	455.4250 kHz	454.5750 kHz	
	PKT-L	1170 Hz	0	-330 Hz	456.170 kHz	456.500 kHz	
		1700 Hz	0	0	456.700 kHz	456.700 kHz	
	2125 Hz	0	0	457.125 kHz	457.125 kHz		
PKT-F	2210 Hz	0	0	457.210 kHz	457.210 kHz		
		0	0	-	-		
USER		±5000	±5000	450~460 kHz	450.0 ~ 460.0 kHz		

## Menu Programming - Selection & Settings

SELECTED FILTER OFFSETS ACCORDING TO MODE							
MODE		SELECTED FILTER BANDWIDTH					
		6 kHz	2.8 kHz	2.4 kHz	2.0 kHz	500 Hz	250 Hz
SSB	LSB	0	0	-50 Hz	-150 Hz	-500 Hz	-500 Hz
	USB	0	0	-50 Hz	-150 Hz	-500 Hz	-500 Hz
CW	400 Hz	+2600 Hz	+1150 Hz	+950 Hz	+650 Hz	0	0
	500 Hz	+2500 Hz	+1050 Hz	+850 Hz	+550 Hz	0	0
	600 Hz	+2400 Hz	+950 Hz	+750 Hz	+450 Hz	0	0
	700 Hz	+2300 Hz	+850 Hz	+650 Hz	+350 Hz	0	0
CW-R	800 Hz	+2200 Hz	+750 Hz	+550 Hz	+250 Hz	0	0
	400 Hz	+2600 Hz	+1150 Hz	+450 Hz	+650 Hz	0	0
	500 Hz	+2500 Hz	+1050 Hz	+350 Hz	+550 Hz	0	0
	600 Hz	+2400 Hz	+950 Hz	+250 Hz	+450 Hz	0	0
AM	700 Hz	+2300 Hz	+850 Hz	+650 Hz	+350 Hz	0	0
	800 Hz	+2200 Hz	+750 Hz	+550 Hz	+250 Hz	0	0
AM	Synchronous	±2800 Hz	±1200 Hz	±1000 Hz	±800 Hz	±150 Hz	±70 Hz
FM	Narrow	0					
RTTY-L	H 170 Hz	+800 Hz	0	0	0	0	0
	H 425 Hz	+600 Hz	0	0	0	0	0
	H 850 Hz	+450 Hz	0	0	0	0	0
	L 170 Hz	+1640 Hz	0	0	0	0	0
RTTY-U	L 425 Hz	+1520 Hz	0	0	0	0	0
	L 850 Hz	+1300 Hz	0	0	0	0	0
	H 170 Hz	+800 Hz	0	0	0	0	0
	H 425 Hz	+660 Hz	0	0	0	0	0
	H 850 Hz	+450 Hz	0	0	0	0	0
	L 170 Hz	+1640 Hz	0	0	0	0	0
	L 425 Hz	+1520 Hz	0	0	0	0	0
	L 850 Hz	+1300 Hz	0	0	0	0	0
PKT-L	1170 Hz	+1850 Hz	0	0	0	0	0
	1700 Hz	+1300 Hz	0	0	0	0	0
	2125 Hz	+900 Hz	0	0	0	0	0
	2210 Hz	+800 Hz	0	0	0	0	0
PKT-F		0					
USER							



## Transceiver Function Setting Table

Func. No.	Function	Setting Range	Default
0-1	MEMORY GROUP 1 CHANNELS	1 ~ 99	01-99
0-2	MEMORY GROUP 2 CHANNELS	0 ~ 99	OFF
0-3	MEMORY GROUP 3 CHANNELS	0 ~ 99	OFF
0-4	MEMORY GROUP 4 CHANNELS	0 ~ 99	OFF
0-5	MEMORY GROUP 5 CHANNELS	0 ~ 99	OFF
0-6	QUICK MEMORY CHANNELS	1 ~ 5	5
0-8	V ► M AUTO CHANNEL UP	ON / OFF	OFF
1-0	VFO A & B DIAL SPEED	x 2, x 4	x 4
1-1	SHUTTLE JOG DIAL SPEED	1 ~ 100 mS	50 mS
1-2	IF SHIFT / WIDTH STEP SIZE	10 / 20 Hz	10 Hz
1-3	MAIN VFO-A TUNING STEP SIZE	0.625 ~ 20 Hz	10 Hz
1-4	SUB VFO-B TUNING STEP SIZE	0.625 ~ 20 Hz	10 Hz
1-5	CHANNEL STEP SIZE	1 ~ 100 kHz	10 kHz
1-6	QUICK SPLIT OFFSET	1 ~ 100 kHz (±)	5 kHz
1-7	AUTOMATIC SELECTION OF THE AGC DECADE TIME	ON/OFF	OFF
1-8	CLAR M-TUNE FUNCTION	ON / OFF	ON
1-9	CLAR TUNING STEP SIZE	0.625 ~ 20 Hz	10 Hz
2-0	SCAN PAUSE	ON / OFF	ON
2-1	SCAN RESUME MODE	CAR STOP / CAR SLOW / CAR TIME	CAR STOP
2-3	MEMORY SCAN SPEED (DWELL TIME)	100 ms ~ 1 s	200 ms
2-4	VFO SCAN SPEED (DWELL TIME)	1 ~ 100 ms	10 ms
2-5	AUTO MEMORY WRITE	OFF / GROUP 1 / GROUPS ALL	OFF
2-6	MEMORY SCAN SKIP	OFF / ALL	OFF
2-7	SCAN DELAY TIME	1 ~ 10 s	5 s
2-9	IF NOTCH MODE	IF NOTCH / AUTO / SELECT	IF NOTCH
3-0	FREQUENCY DISPLAY	OFFSET / CARRIER	OFFSET
3-1	DISPLAY RESOLUTION	10 Hz / 100 Hz / 1 kHz	10 Hz

## Transceiver Function Setting Table

Func. No.	Function	Setting Range	Default
3-2	ETS (Enhanced Tuning Scale)	CLAR / DIAL	CLAR
3-3	Transverter Frequency Display	OFF / 50 / 144 / 430	OFF
3-4	Dimmer (Display Brightness)	LOW / HI	HI
3-5	Panel Display Mode	PITCH / CLAR / CH FREQ / OFFSET	CLAR
3-6	SUB VFO-B S-Meter	ON/OFF	ON
3-7	MAIN VFO-A Meter Peak-Hold	ON / OFF	OFF
3-8	SUB VFO-B Meter Peak-Hold	ON / OFF	OFF
4-0	RF Output Power (limit)	100 / 50 / 10 W	100 W
4-1	KEY & PANEL BEEPER	ON / OFF	ON
4-2	KEY & PANEL BEEP PITCH	220 ~ 7040 Hz or BEEP TUN ON/OFF	880 Hz
4-3	TUNING DRIVE (AUTO POWER-DOWN)	10 / 50 / 100 W	50
4-4	TX AUDIO EDSP	OFF, 1, 2, 3, 4	OFF
4-5	<i>EDSP Filters</i> SSB LPF SSB HPF CW BPF AM LPF AM HPF DIGITAL FILTER	100 ~ 3200 Hz 100 ~ 1800 Hz 60 / 120 / 240 Hz 1000 ~ 3200 Hz 100 ~ 1800 Hz PKT / SSTV / FAX	3200 Hz 100 Hz 240 Hz 3200 Hz 100 PKT
4-6	DVS RX RECORDING	MAIN VFO / SUB VFO	MAIN VFO
4-7	DVS PTT CONTROL	ON / OFF	ON
4-8	HEADPHONE AUDIO	MONO / STEREO 1 / STEREO 2	STEREO 1
4-9	AF GAIN BALANCE CONTROL	SEPARATE / BALANCE	SEPARATE
5-0	8.2 MHZ FILTER	2.4 K ON / OFF	ON
5-1	8.2 MHZ FILTER	2.0 K ON / OFF	OFF
5-2	8.2 MHZ FILTER	500 ON / OFF	ON
5-3	8.2 MHZ FILTER	250 ON / OFF	OFF
5-4	455 KHZ FILTER	2.4 K ON / OFF	ON
5-5	455 KHZ FILTER	2.0 K ON / OFF	OFF
5-6	455 KHZ FILTER	500 ON / OFF	OFF
5-7	455 KHZ FILTER	250 ON / OFF	OFF
5-8	SUB VFO RX FILTER	ON / OFF	OFF
5-9	TX EDSP FILTER	6.0 kHz / 2.0 kHz	6.0 kHz

## Transceiver Function Setting Table (cont.)

Func. No.	Function	Setting Range	Default
6-0	RTTY SHIFT	170 / 425 / 850 Hz	170 Hz
6-1	RTTY POLARITY	NORMAL / REVERSE	NORMAL
6-2	RTTY TONE PAIR	HIGHT TONE / LOW TONE	HIGH TONE
6-3	RTTY FREQUENCY DISPLAY	CARRIER / OFFSET	OFFSET
6-4	PACKET FREQUENCY DISPLAY OFFSET	±3.000 kHz	-2.125 kHz
6-5	PACKET TONE FREQUENCY	1170 - 2215 Hz	2125 kHz
6-7	CTCSS TONE SELECT	67.0 - 250.3 Hz	88.5 Hz
6-8	TONE MODE	CONTINUOUS / BURST	CONTINUOUS
6-9	REPEATER SHIFT (TX OFFSET)	0 - 200 kHz	100 kHz
7-0	ELECTRONIC KEYSER MODE	IAMBIC 1 / BUG / IAMBIC 2	IAMBIC 1
7-1	KEYER DOT WEIGHTING	0 (0.5) ~ 127 (2.0)	10 (1:1)
7-2	KEYER DASH WEIGHTING	0 (2.0) ~ 127 (4.5)	30 (1:3)
7-3	KEYER CONTEST NUMBER	0000 - 9999	0000
7-4	KEYER BREAK-IN TIME	0 - 30 ms	5 ms
7-5	KEYER DELAY TIME	0.00 - 5.10	0.00
7-6	CONTEST NO. PLAYBACK STYLE	ID NO. 1, 2, 3, 4, 5, 6, 7, 8, 9, STYLE	
7-7	EDSP MODULATION & DEMODULATION	SSB (Rx) 100-3100Hz, 300-2800 Hz, Off SSB (Tx) 100-3100 Hz, 150-3100 Hz, 200-3100 Hz, 300-3100 Hz, Off CW (Rx) 100-3100 Hz, Off AM (Rx) 70-3800 Hz, Off	OFF OFF OFF OFF
7-8	SUB RECEIVER	ON / OFF	ON
7-9	REMOTE CONTROL FUNCTION	EL / PANEL / AIO / BIO	EL
8-0	FAST KEY OPERATION	CONTINUOUS / TOGGLE	TOGGLE
8-1	LOCK SELECTION	DIAL / PANEL / PRIMARY	DIAL
8-2	SPLIT OPERATION	NORM / AUTO / A-B	NORM
8-4	FRONT END RF AMP SELECTION	TUNED / FLAT	FLAT
8-5	ANT KEY FUNCTION	AUTO / ON / OFF	AUTO
8-6	USER SETTING MODE DISPLAY OFFSET RECEIVE PLL RECEIVE CARRIER TRANSMIT PLL TRANSMIT CARRIER RTTY OFFSET EASY SET	LSB, USB, CW(U&L), RTTY (U&L), PKT ± 5.000 kHz ± 5.000 kHz 450.000 ~ 460.000 kHz ± 5.000 kHz see table 2 on the next page ± 5.000 kHz OFF / SSTV / FAX	LSB  Mode-Dependent see table 1 on the next page 0.000 kHz OFF

Transceiver Function Setting Table (cont.)

8-7	SUB RX AGC	AUTO / SLOW / FAST	AUTO
8-8	TUNER	ON / OFF	ON
8-9	CARRIER OFFSET RX LSB CARRIER TX USB CARRIER PROC. LSB CARRIER RX LSB CARRIER TX USB CARRIER PROC. USB CARRIER TX AM CARRIER	-0.200 ~ 0.500 kHz -0.200 ~ 0.500 kHz -0.200 ~ 0.500 kHz -0.200 ~ 0.500 kHz -0.200 ~ 0.500 kHz -0.200 ~ 0.500 kHz -0.200 ~ 0.500 kHz	0.000 kHz

Table1. Default USER Function Settings

dSP-OfSt						
LSB	USB	CW (USB)	CW (LSB)	RTTY (LSB)	RTTY (USB)	PKT (LSB)
0.000 kHz	0.000 kHz	0.700 kHz	-0.700 kHz	-2.125 kHz	2.125 kHz	-2.125 kHz
r-PLL						
LSB	USB	CW (USB)	CW (LSB)	RTTY (LSB)	RTTY (USB)	PKT (LSB)
-1.450 kHz	1.450kHz	0.700 kHz	-0.700 kHz	-2.210 kHz	2.210 kHz	-2.120 kHz
r-cRr						
LSB	USB	CW (USB)	CW (LSB)	RTTY (LSB)	RTTY (USB)	PKT (LSB)
456.450 kHz	453.550 kHz	454.300 kHz	455.700 kHz	457.210 kHz	452.790 kHz	457.120 kHz
t-PLL						
LSB	USB	CW (USB)	CW (LSB)	RTTY (LSB)	RTTY (USB)	PKT (LSB)
-1.500 kHz	1.500 kHz	0.700 kHz	-0.700 kHz	-2.125 kHz	2.125 kHz	-2.120 kHz
t-cRr						
LSB	USB	CW (USB)	CW (LSB)	RTTY (LSB)	RTTY (USB)	PKT (LSB)
456.500 kHz	453.500 kHz	455.000 kHz	455.000 kHz	455.000 kHz	455.000 kHz	457.120 kHz
rttY-5Et						
LSB	USB	CW (USB)	CW (LSB)	RTTY (LSB)	RTTY (USB)	PKT (LSB)
0.000 kHz	0.000 kHz	0.000 kHz	0.000 kHz	-0.170 kHz	0.170 kHz	0.000 kHz

Table 2. TX CARRIER Adjustment Ranges

LSB	456.300 ~ 460.000 kHz	PKT	450.000 ~ 453.700 kHz or 456.300 ~ 460.000 kHz
USB	450.000 ~ 453.700 kHz	all others	450.000 ~ 460.000 kHz

## Installing Internal Accessories

This section contains the installation procedures for installable options available for the FT-1000MP. A complete list of options and their corresponding Yaesu P/N is provided on page 6 of this manual. Please check with your dealer for pricing and availability.

### TCXO Units

Temperature-Compensated Crystal Oscillators are the heart of the master reference oscillator used throughout transceiver circuitry. Two optional TCXO units are available for installation into the FT-1000MP. The  $\pm 2$ -ppm TCXO-4 is a small module that plugs into the connector provided on the existing REF-UNIT PCB, while the  $\pm 0.5$ -ppm TCXO-6 replaces the factory-installed REF-UNIT. Both units provide enhanced frequency stability over the standard  $\pm 10$ -ppm module.

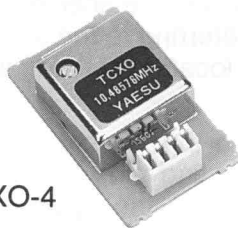

TCXO-4

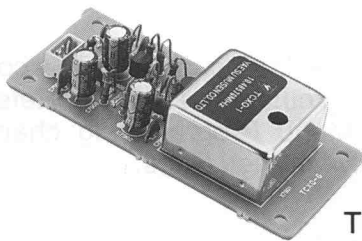

TCXO-6

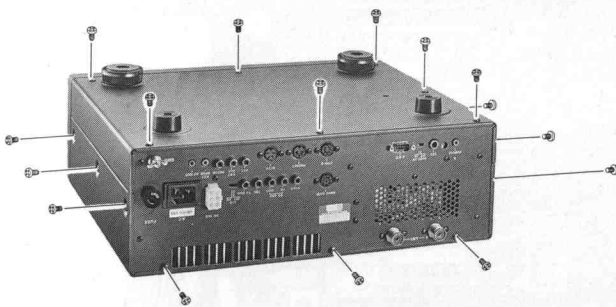

 If you also have the optional YF-115C Sub Receiver filter, now would be a good time to install it, as its mounting position is also exposed during the TCXO installation procedures.

### TCXO-4 Installation

- Disconnect all cables from the transceiver.
- Remove the *three* screws on each side of the transceiver, and the *three* along the top edge of the rear panel, then lift off the top cover.
- Remove the *seven* screws from the bottom of the transceiver, then lift off the bottom cover.
- Locate the REF UNIT in the top left corner of the right chassis side (see the photograph below), and the empty space labeled **TCXO-4 OPTION**.
- Position the TCXO-4 Unit so that its empty 3-pin connector, and mounting hole mate with the protruding 3 pins and nylon mount on the REF UNIT.
- Gently press the unit into place, so that it is firmly seated, and the nylon mounting tabs "mushroom" through the hole and lock the unit in place.
- Locate the three-wire plug installed in jack J4702 (labeled REF). Unplug this connector and plug it into the jack next to it - J4703 (labeled TCXO-4). Use a small screwdriver to pry up the rear edge of the connector, and avoid pulling on the wires.
- This completes the installation. Replace the bottom then top cover.

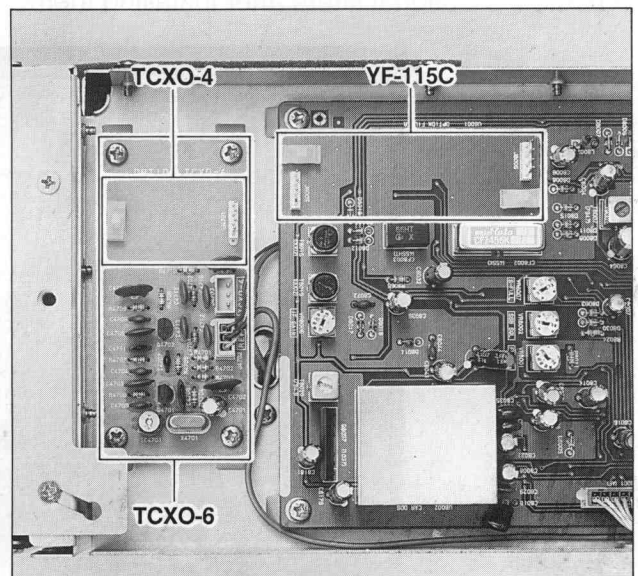

REF UNIT and SUB RX UNIT OPTION LOCATIONS

## Installing Internal Accessories

### TCXO-6 Installation

- Disconnect all cables from the transceiver.
- Remove the *three* screws on each side of the transceiver, and the *three* along the top edge of the rear panel, then lift off the top cover.
- Remove the *seven* screws from the bottom of the transceiver, then lift off the bottom cover.
- Locate the REF UNIT in the front right corner of the chassis (see photo on previous page), and remove the wiring connector from the board. Use a small screwdriver to pry up the rear edge of the connector, and avoid pulling on the wires.
- Removed the *four* screws at the corners of the board, and remove the REF UNIT.
- Position the new TCXO-6 in place, and use the same screws just removed to affix the new board in place. Reinstall the wiring connector.
- This completes the installation, replace the top cover and screws removed above (unless installing other options now).

### Main Receiver 2nd and 3rd IF Filters

A total of 5 optional crystal IF filter units can be installed in addition to the factory-installed filters (see the table at the top of the next column for filter part number and bandwidth). Contact your dealer for pricing, availability and ordering. These filters include small boards with connectors, so no soldering is necessary for their installation.

**Important!** After filter installation, *front-panel selection is not possible until individual filters are enabled via menu programming* (menus 5-0 ~ 5-8). Refer to the Menu Programming chapter and enable the optional filters after installing them.

Optional IF Filter Units			
8.2 MHz 2nd IF		455 kHz 3rd IF	
Yaesu P/N	BW	Yaesu P/N	BW
YF-114SN	2.0 kHz	YF-110SN	2.0 kHz
YF-114CN	250 Hz	YF-115C*	500 Hz
		YF-110CN	250 Hz
* Collins Mechanical Filter			

☞ If you also have the optional TCXO-4 or TCXO-6, now would be a good time to install it, as its mounting position is also exposed during the optional filter installation procedure.

### Filter Installation

- Disconnect all cables from the transceiver.
- Remove the *three* screws on each side of the transceiver, and the *three* along the top edge of the rear panel, then lift off the top cover.
- Remove the *seven* screws from the bottom of the transceiver, then lift off the bottom cover.
- On the underside of the transceiver chassis, locate the IF UNIT. Referring to the photograph below, determine the location of the filter(s) you are installing.
- Position each filter so that its connectors are aligned with the mounting pins on the board, and push it into place, so the nylon mounting tabs "mushroom" through the holes and lock the unit in place.
- Replace the bottom and top cover (unless installing other options now). Refer to page 89 of the Menu Programming chapter to enable newly-installed filters.

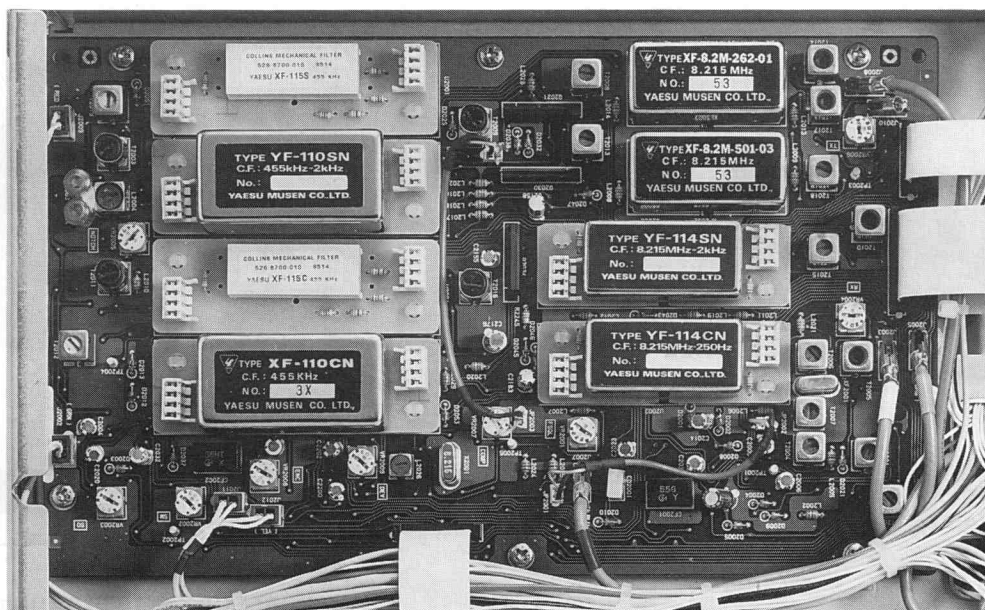

### Sub Receiver CW Narrow Filter

The optional YF-115C Collins Mechanical filter (500 Hz BW) is available for the 455-kHz Sub Receiver 3rd IF for enhanced reception. Only top cover removal is required for installation.

#### Installation

- Disconnect all cables from the transceiver.
- Remove the *three* screws on each side of the transceiver, and the *three* along the top edge of the rear panel, then lift off the top cover.
- Locate the SUB RX Unit on the right side of the set.
- Referring to the photograph on page 99, determine the location of the Sub Rx filter you are installing.
- Position the filter so that its connectors are aligned with the mounting pins on the board, and push it into place, so the nylon mounting tabs "mushroom" through the hole and lock the unit in place.
- Replace the top cover, unless installing the TCXO-4 options now (TCXO-6 requires both top and bottom cover removal). Refer to the Menu Programming chapter to enable the newly-installed filter (Menu Selection 5-8).

### Lithium Battery Replacement

A 3-V Type CR2032 Lithium Battery (BT5001) is located on the CNTL UNIT board (underside) of the transceiver. This maintains the memorized data in your radio. Battery life is normally greater than five years, however, should replacement be needed, perform the following steps:

- With the top and bottom covers removed, note the location of the battery. Using your finger, slide the battery inward (you will feel slight pressure by the mounting spring), then slightly pry it up and outward so that it ejects freely through the slots in the battery holder.
- Carefully note battery polarity with the positive (+) side facing upward, and battery-type information. Install the replacement battery in the reverse manner.

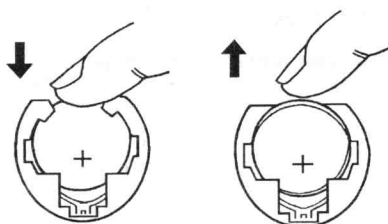

### Memory Back Up Switch

The rear panel memory **BACKUP** switch is normally kept in the ON position to ensure your memorized data is maintained (by a small amount of power from the lithium battery) when the radio is off, or the DC power source is removed.

- If you do not plan to operate your radio for extended periods of time, slide this switch to the OFF position to conserve battery life.
- Ensure the radio is on when sliding the switch back to the ON position, as this reduces the initial current demand on the battery by the radio's circuits from an un-powered state.
- Note: Memorized settings are lost and the radio returns to factory default settings when turning off the backup battery.

### Internal 13.5V Fuse Replacement

The rear panel 13.5V jack provides regulated, *separately fused* 13.5 VDC at up to 200 mA, to power external low-current devices. If your device requires more current, use a separate power source. In the event the internal fuse blows, it can be replaced. However, this requires moderate transceiver disassembly.

- With the top cover removed, locate the two screws mounting the fan assembly to the PA Unit heat sink. Remove the screws and move the fan assembly to one side.
- Remove the remaining four heat sink screws and lift the PA assembly from the chassis. You will need to unplug the mini coax (with the yellow band) from the RX ANT IN connector on the BPF UNIT.
- Remove the four screws from the PA Unit mount, and remove the mount to expose the BPF UNIT, and fuse labeled FH1001 (below).

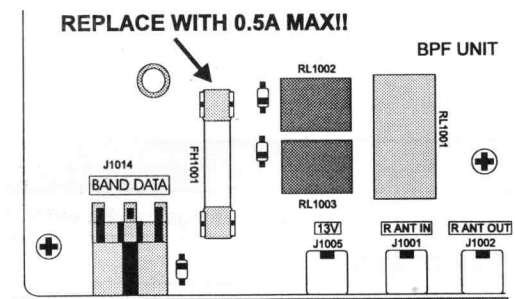

- Using a pair of fuse pullers, remove the blown fuse and replace only with a similar fast-blow type fuse (0.5A maximum).
- Reassemble the PA UNIT mount, yellow-banded coax cable, PA UNIT, and fan assembly in reverse order, then replace the top cover.

## Installing Internal Accessories

### Tuning Knob Torque Adjustment

If the tuning knob is too tight or too loose for your preference, and if you have a 2-mm ( $5/64$ " ) Allen wrench, you can adjust the torque.

- Pull the knurled rubber ring off of the tuning knob.

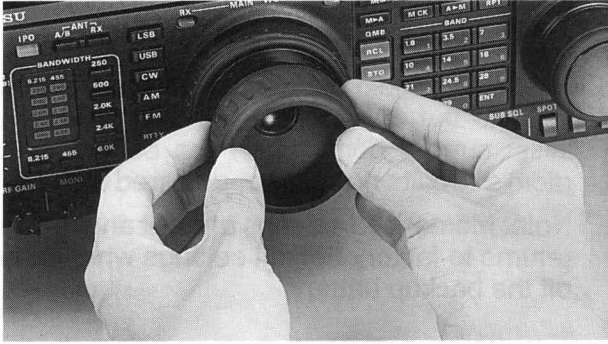

- Locate the hole in the edge of the tuning knob, and use the Allen wrench to loosen the set screw accessible through the hole, just enough to allow the knob to be pulled off the shaft.

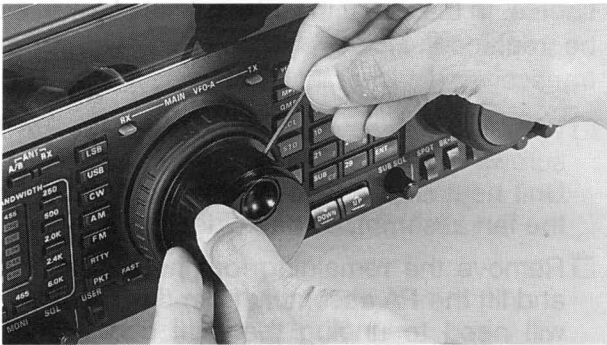

- Turn the exposed shaft tension spring counter-clockwise to loosen the torque, or clockwise to tighten.

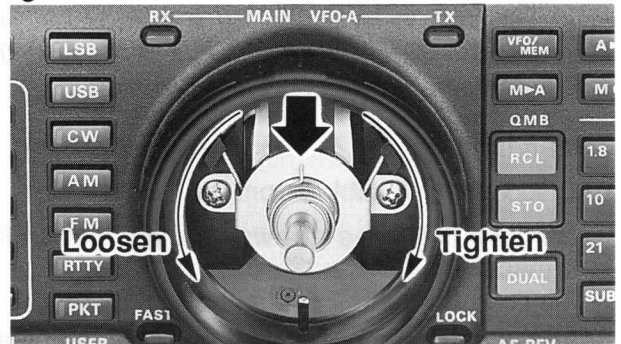

- Replace the knob, tighten the set screw, and replace the rubber ring.

### Power-on Settings

Some or all transceiver settings can be reset to their factory-default states using one of the following power-on routines:

<b>[29] 0 + POWER</b>	Resets all menu setting to factory-default.
<b>[SUB] CE + [ENT] + POWER</b>	Resets all memories (except menu settings) to factory-default.
<b>[SUB] CE + [29] 0 + [ENT] + POWER</b>	CPU master reset for all memories and menu settings



## DC Operation

The DC version of the FT-1000MP is supplied without the internal AC switching-type power supply. A dual-fused 3-meter-long DC cable, part number T9018320, is supplied instead, for operating the transceiver from an external source of 13.1- to 15.2-V DC (13.5 V nominal) at up to 20 amperes. The FP-26 internal AC supply is available as an option for the DC version of the FT-1000MP, and the DC cable is available as an option for the AC/DC version. If your FT-1000MP has the FP-26 installed, and you desire to operate from a DC supply, read the notice below, and perform the modification in the paragraph that follows, otherwise proceed directly to the *Installation* section.

### Notice!

Changing an AC-version (FP-26 installed) FT-1000MP for DC operation requires moving the position of an internal plug. Either AC or DC input for operation can be selected, but the plug position must be moved **each time** you change between AC and DC input (see below).

### Enabling DC Input for Operation

- Disconnect all cables from the transceiver.
- Remove the *three* screws on each side of the transceiver, and the *three* along the top edge of the rear panel, then lift off the top cover.
- Remove the *seven* screws from the bottom of the transceiver, then lift off the bottom cover.
- Next remove the upper two screws in either side of the front panel, and loosen the lower two. Then pull the panel forward slightly before folding it down.

**Note** - when folding the panel down, the twisted white cable pair in the top right corner must be removed from its nylon retaining clip and unfolded. When folding the front panel up again, *be sure to fold the cable neatly back into its clip again.*

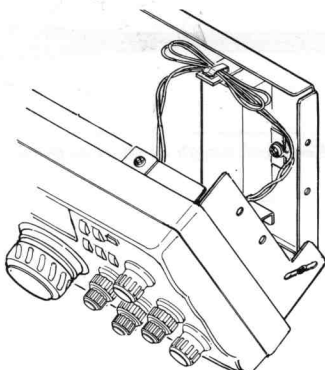

- Locate the AC/DC operation plug through the access cutout.

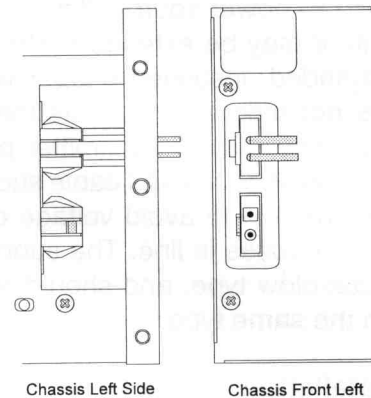

- Press in on the release clip and pull the plug free from the upper (AC operation) connector. Now insert the plug in the lower (DC operation) connector.

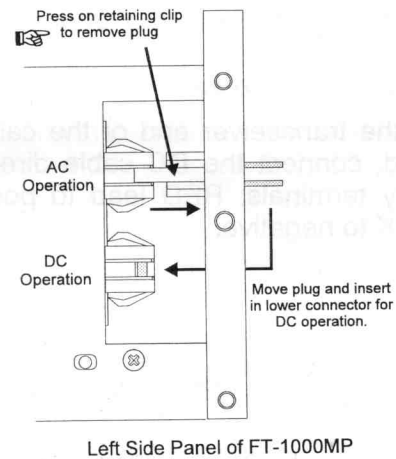

- Fold up the front panel, replace and tighten its screws, then replace the top and bottom covers.

The transceiver is now set up for DC input from the rear panel **DC 13.5V** jack. Remember to repeat the modification and insert the plug in the upper connector when changing back to AC (input) operation.

### Installation

Use the fused DC cable to connect the transceiver to the DC power source. If the cable is not long enough, it may be extended with #12 AWG or larger stranded, insulated copper wire. However, this is not recommended, as the resulting voltage drop may restrict transmitter power output. In any installation, the DC cable should be cut as short as possible to avoid voltage drop while still keeping the fuses in line. The supplied fuses are 20-A, fast-blow type, and should only be replaced with the same type.

### Mobile Installation

- Before connecting the cable, measure the DC voltage at the battery terminals while revving the engine. If the voltage exceeds 15 volts, have the vehicle's voltage regulator adjusted before proceeding.
- Determine just where the transceiver will be located, then route the DC cable to the battery and cut off any excess.
- With the transceiver end of the cable unconnected, connect the DC cable directly to the battery terminals: RED lead to positive, and BLACK to negative.

### Caution!

Our warranty does not cover damage that may result from improper supply voltage or use of an improper fuse.

To avoid damage to the FT-1000MP from switching spikes, always make sure it is switched off before turning your DC power source on or off, or before starting or stopping the engine (in mobile installations).

- Make sure the transceiver **POWER** switch is OFF, and then connect the other end of the cable to the transceiver.
- When transmitting using an external DC source, voltage drop in the DC cable or connections, or poor regulation of the external supply, may cause the display to dim. This can cause distortion of your signal, so you should reduce the **RF PWR** setting until the lamps no longer dim.

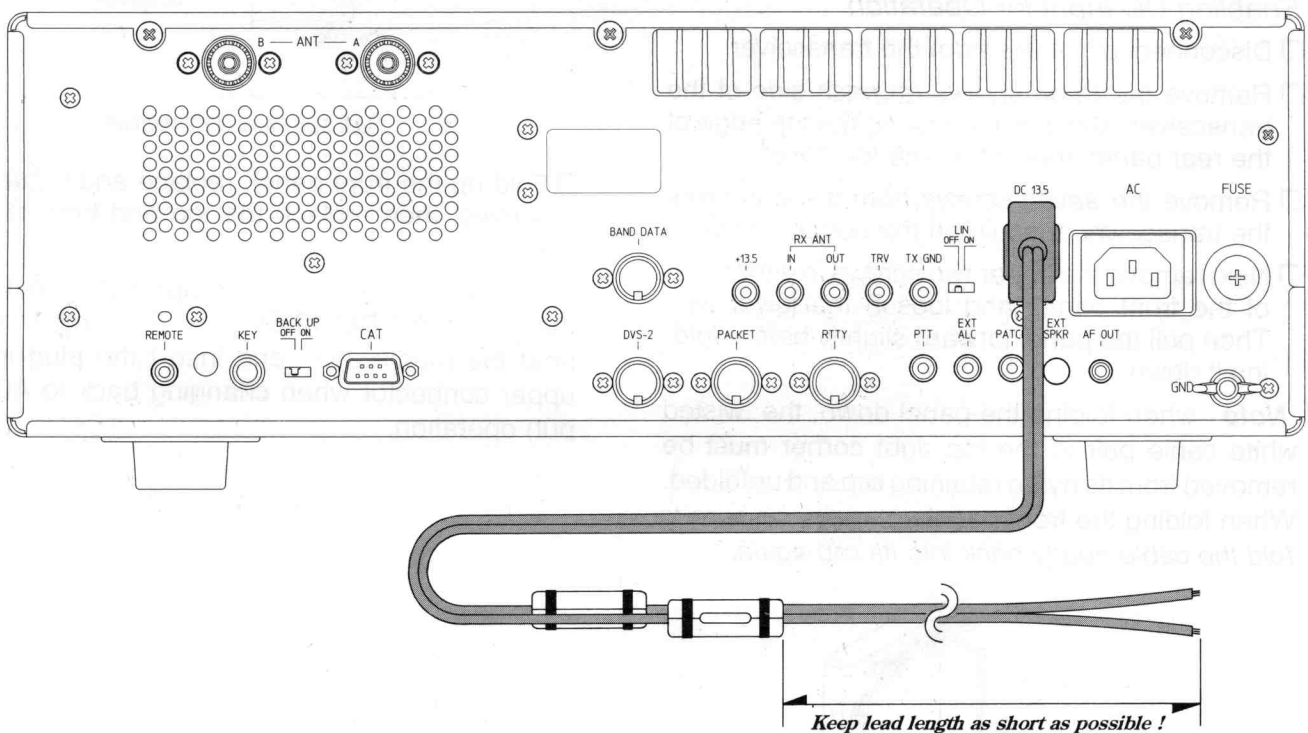



# YAESU

*...leading the way.<sup>SM</sup>*

Copyright 2003  
VERTEXSTANDARD CO., LTD.  
All rights reserved

No portion of this manual  
may be reproduced without  
the permission of  
VERTEXSTANDARD CO., LTD.

Printed in Japan.



E 0 3 9 3 1 0 0 7

0301b-SK